

OPERATING & MAINTENANCE INSTRUCTIONS WITH PARTS LIST

Publication Part No. 117404-23
Published December 2007

KALC Air Hoists

For Capacities:

1, 2, & 3 Ton

**1/2, 1 & 2 Ton Spark
Resistant Models**



IMPORTANT-CAUTION

To safeguard against the possibility of personal injury or property damage, follow the recommendations and instructions of this manual. This manual contains important information for the correct installation, operation, and maintenance of this equipment. All persons involved in the installation, operation, and maintenance of this equipment should be thoroughly familiar with the contents of this manual. Keep this manual for reference and further use.

WARNING

To prevent personal injury, do not use the equipment shown in this manual to lift, support or otherwise transport people, or to suspend unattended loads over people.

FOREWORD

This book contains important information to help you install, operate and maintain your new **YALE** KALC Air Hoist. We recommend that you study its contents thoroughly before putting your hoist to use. Through proper installation, application of correct operating procedures, and by practicing the recommended maintenance suggestions you will be assured maximum service from your hoist.

Complete inspection, maintenance and overhaul service is available for **YALE** Air Hoists at authorized **YALE** Repair Stations. Refer to your telephone directory yellow pages under "HOISTS". They are staffed by qualified factory-trained service men and stock approved **YALE** replacement parts.

Replacement parts information is also included in this book for your convenience. Since it will likely be a long time before parts information is needed, we suggest that, after you have become familiar with operation and preventive maintenance procedures, this book be carefully filed for future reference.

EQUIPMENT ILLUSTRATED AND DESCRIBED HEREIN IS NOT DESIGNED OR SUITABLE FOR LIFTING OR LOWERING PERSONS.

INDEX

	Page
SECTION I GENERAL DESCRIPTION	
Paragraph 1-1 General	3
Paragraph 1-2 Basic Construction	3
Paragraph 1-3 Differences Between Models and Sizes	3
Paragraph 1-4 MAN-GUARD Overload Clutch	3
SECTION II INSTALLATION	
Paragraph 2-1 General	3
Paragraph 2-2 Suspending Hoist	3
Paragraph 2-3 Pre-Installation Checks	4
Paragraph 2-4 Connecting Hoist to Air Service	4
SECTION III OPERATION	
Paragraph 3-1 General	5
Paragraph 3-2 Pre-Operational Hoist	5
Paragraph 3-3 Operating Hoist	5
Paragraph 3-4 Upper and Lower Limit Stops	5
Paragraph 3-5 MAN-GUARD Overload Clutch Operations	5
Paragraph 3-6 Load Chain	6
Paragraph 3-7 Pulling and Pivoting Hoist and Load	6
Paragraph 3-8 Operating Precautions	6
SECTION IV LUBRICATION	
Paragraph 4-1 General	6
Paragraph 4-2 Service Air Line Lubricator	6
Paragraph 4-3 Lubricate Load Chain	7
Paragraph 4-4 Change Gearcase Oil	7
Paragraph 4-5 Lubricate Upper Hook and Lower Block Assembly	7
SECTION V MAINTENANCE	
Paragraph 5-1 General	7
Paragraph 5-2 Thirty-Day Inspection	7
Paragraph 5-3 Six-Month Inspection	10
Paragraph 5-4 Annual Inspection	10
Paragraph 5-5 Inspection - 5000 Hour or Five Year	11
SECTION VI TROUBLESHOOTING	12
SECTION VII DISASSEMBLY AND REASSEMBLY	
Paragraph 7-1 General	13
Paragraph 7-2 Disassembly of Hoist into Subassemblies	13
Paragraph 7-3 Rebuild of Hoist Frame, Sprocket Gear, Sprocket Shaft and Chain Guide	15
Paragraph 7-4 Rebuild of Load Brake and Overload Clutch Assembly	17
Paragraph 7-5 Rebuild of Lower Block and Load Chain Assembly	19
Paragraph 7-6 Rebuild of Pendant Throttle Control Assembly	20
Paragraph 7-7 Rebuild of Supply Head Assembly	20
Paragraph 7-8 Rebuild of Air Motor	21
Paragraph 7-9 Reassembly of Hoist From Subassemblies	21
Paragraph 7-10 Testing Hoist	21
Paragraph 7-11 Test Procedure For Checking Operation of Overload Clutch	22
SECTION VIII REPLACEMENT PARTS	23

Notice: Information contained in this book is subject to change without notice.

SECTION I - GENERAL DESCRIPTION

1-1. GENERAL. These YALE KALC Air Hoists are precision built chain type hoists which are built in three capacity sizes: 1, 2, and 3 ton. All models use coil type load chain and have pendant throttle controls. There are model variations with hook or lug type suspensions. Hoists are also provided in spark resistant models and corrosion resistant models. (Note: Spark resistant models have capacity ratings lower than standard models).

1-2. BASIC CONSTRUCTION. All sizes and models of these YALE KALC Air Hoists are of the same basic design, having many common and interchangeable parts. They consist primarily of an aluminum alloy frame and gearcase cover which houses an automatic load brake and gear train. An air motor is mounted on the rear of the frame. An upper hook or lug bracket for suspending the hoist is attached to the top of the frame. An alloy steel coil load chain with lower block assembly is employed to raise and lower loads. Upper and lower limits of hook travel are limited by chain mounted limit stops. Hoist operation is controlled by a pendant throttle control assembly.

1-3. DIFFERENCES BETWEEN MODELS AND SIZES. The main differences between hoist models are in the reeving of the load chain and the suspension employed. These are described in Paragraphs a and b, below.

- a. On standard 1 ton capacity hoists, the load chain is single reeved (one part of chain); on standard 2 ton capacities, the chain is double reeved (two parts of chain); on standard 3 ton capacities, the chain is triple reeved (three parts of chain). Coil type chain is full-flexing, electric welded, link chain; carburized steel on standard and corrosion resistant models and stainless steel on spark resistant models. Both types are especially designed for use in hoisting and have special calibrated pitch. (Note: On corrosion resistant models, the load chain is zinc plated).
- b. Suspension differences include a conventional hook type mounting and a lug type mounting. Hook suspension allows portability permitting hoist to be easily moved from job to job. Lug suspension permits hoist to be rigidly mounted to overhead structure or attached to YALE Rigid Mount Trolleys, affording unusual headroom advantage.

1-4. MAN-GUARD OVERLOAD CLUTCH. YALE KALC Air Hoists have a **MAN-GUARD** label on the sides of the counterweighted cover and are equipped with an overload clutch that is designed to help guard against excessive overloads. The clutch is built into the load brake gear. It is a cone-friction clutch that connects the first reduction gear (load brake gear) to the load brake output pinion shaft. A belleville disc spring provides clutch pressure between the gear and its cone shaped gear center. An excessive overload causes the load brake gear to rotate without turning the gear center and output pinion shaft. The clutch is located between the load brake and the motor, thus allowing load brake to function in its normal manner. See Paragraph 3-5 for operation.

SECTION II - INSTALLATION

2-1. GENERAL. YALE KALC Air Hoists are completely lubricated and load tested before being shipped from the factory. The hoist is shipped with pendant handle and hose assembly packed loose in the shipping carton. See Paragraph 2-2.e for attachment. To place hoist in service, attach to a suitable overhead suspension (Paragraph 2-2) in area to be used; perform pre installation check (Paragraph 2-3); and connect hoist to air service (Paragraph 2-4).

2-2. SUSPENDING HOIST.

- a. On hook suspended hoists, select a suitable overhead support in area hoist is to be used (one capable of holding combined weight of hoist and its capacity load) and hang hoist up. **Be certain that upper hook is firmly seated in center of hook saddle and that the spring safety latch is properly closed over hook opening.** In some cases, it may be necessary to first remove spring latch before hook will fit over a support. Reinstall latch after hook is engaged.
- b. On lug suspended hoists, select a suitable overhead support in area hoist is to be used (one capable of holding combined weight of hoist and its capacity load). Mount hoist using through bolts of appropriate size to fit mounting holes in suspension lug at top of hoist. (See table below). Use only suspension bolts provided by Yale•Lift-Tech.

 WARNING	
The structure used to suspend hoist must be of sufficient strength to withstand reasonable forces to which hoist and support may be subjected. Hoist must be aligned with load to avoid side pulls.	

SUSPENSION LUG BOLTS SIZES AND SPACING

Hoist Capacity (tons)		Bolt Diameter (in)	Distance Between Holes (in)
Std.	S.R.*		
1	1/2	5/8	3-1/8
2	1	1	5
3	2	1-1/4	6

*S.R. = Spark Resistant Models

c. On lug suspended hoists, the suspension lug is factory oriented to cross mount the hoist. This is the recommended orientation. To rotate the lug 90° for parallel mounting, follow instructions below:

- (1) On 1/4 through 1 ton hoists, remove the two screws securing the anti-rotation bracket and remove the bracket. Rotate the suspension lug in 90° increments. Reinstall the anti-rotation bracket and secure with two screws and lock washers.

(2) On hoists with two parts of chain: remove hex socket head screw in lower lock plate. Remove lower lock plate. Rotate suspension lug to selected position and replace lock plate and hex socket head screw.

(3) On hoists with three parts of chain: the hanger bracket must first be removed from the hoist to provide access to suspension nut per Section VII, Paragraph 7-2.a.(4) and Figures 7-1 and 7-2.

To removed lug bolt, follow instructions in Section VII, Paragraph 7-3.b.(3). With bolt removed lift lug from hanger and reposition as desired. The lug is located and prevented from turning by integral lugs on adjacent surfaces of the lug and the hanger. Reinstall lug bolt, spherical washers and nut. Align hole in nut and lug bolt. Drive grooved pin through nut and suspension bolt to a position flush with nut, or not more than 1/8" protruding. Reassemble hanger bracket to hoist.

▲WARNING

Be certain to replace grooved pin through nut and lug bolt. Grooved pin must be tight.

d. On rigid mount trolley suspended hoists, the trolley side plates must be properly spaced so trolley will fit I-beam on which hoist will operate. Adjustment for various I-beam sizes is accomplished by rearrangement of spacer washers on the through bolts which connect trolley side plates to suspension lug on hoist. Refer to instruction sheet furnished with **YALE** Rigid Mount Trolleys for complete instructions.

▲WARNING

If trolley is mounted on an open-end beam, end stops must be installed to prevent trolley from running off the end of the beam resulting in injury to operator and others and damages to load and other property.

e. To connect pendant throttle control, refer to Figure 8-8. The hose with a straight connection at the top (Ref. No. 10) attaches to the left connection of the supply head as shown. The hose with the long elbow at the top connects to the upper right connection and the hose with the short elbow at the top connects to the lower right connection of the supply head. Assemble the parts at the upper end of the strain relief cable as shown. Make the cable tight enough to support the weight of the handle and hoses before tightening the wire rope clips.

f. If chain container is to be used on hoist, install it following instructions furnished with container.

2-3. PRE-INSTALLATION CHECK. Check Oil Level. (Figure 4-1) The gear case has been filled with oil, to the proper level at the factory. However, the oil level should be checked before hoist is operated. Remove pipe plug from oil filler on side of hoist frame. Replace with supplied oil hole cover. Check oil level by removing oil level plug (side of frame). Observe if oil level is even with bottom of tapped hole. If it is not, add oil, as specified in paragraph 4-4c. Also check load chain. Be sure it is properly lubricated. See paragraph 4-3.

2-4. CONNECTING HOIST TO AIR SERVICE.

- Connect hoist to nearest filtered and lubricated air source using 3/4" I.D. air hose (see Figure 2-1). Avoid use of hose assemblies of smaller diameters that will cause air flow restrictions and reduce hoist performance.
- If hoist is suspended by trolley, provide sufficient hose to reach from air source to farthest point of trolley travel. **YALE** Hose Trolleys are recommended to keep hose up out of the way.

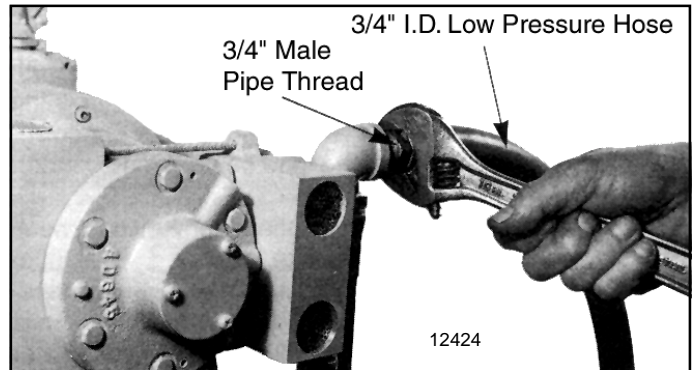

Figure 2-1. Connecting Air Hose to Hoist

- A filter and lubricator unit (Figure 2-2) must be installed between air source and hoist, as close to hoist as possible. These keep air flowing to hoist free of dirt and add lubricant to air so internal parts of motor are constantly lubricated. Use a good grade of spindle oil, approximate viscosity 180 ssu at 100° F., air powered tool oil, or S.A.E. 10W machine oil. Yale•Lift-Tech distributors can provide filter-lubricator units.

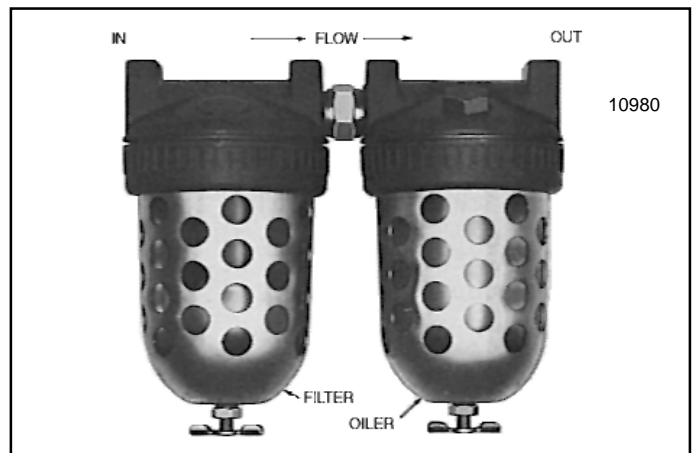

Figure 2-2. Air Filter and Lubricator Unit

- The recommended operating air pressure for all capacities of **YALE** Air Hoists is 90 psi. When line pressure exceeds 100 psi (at hoist when hoist is operating), it is recommended that a pressure regulator valve be provided in the air supply line to maintain proper pressure. Although there is a wide range of pressures within which the hoists will operate, motor efficiency may decrease more rapidly than the drop in air pressure on a percentage basis. Refer to "Performance Charts," See Figure 2-3.

1 Ton Capacity Hoist

Load	500 lb.		1000 lb.		1500 lb.		2000 lb.		
	Up	Down (max)	Up	Down (max)	Up	Down (max)	Up	Down	
								Min	Max
60	40	36	33	36	28	36	20	25	36
70	43	39	36	39	31	39	24	28	39
80	47	42	39	42	34	42	28	32	42
90	50	47	42	47	38	47	30	36	47

2 Ton Capacity Hoist

Load	1000 lb.		2000 lb.		3000 lb.		4000 lb.		
	Up	Down (max)	Up	Down (max)	Up	Down (max)	Up	Down	
								Min	Max
60	19	17	16	17	14	17	10	12	17
70	21	19	17	19	15	19	12	14	19
80	22	20	19	20	16	20	14	16	20
90	24	22	20	22	18	22	15	18	22

3 Ton Capacity Hoist

Load	1500 lb.		3000 lb.		4500 lb.		6000 lb.		
	Up	Down (max)	Up	Down (max)	Up	Down (max)	Up	Down	
								Min	Max
60	13	11	11	11	9	11	6	8	11
70	14	12	12	12	10	12	8	9	12
80	15	13	13	13	11	13	9	10	13
90	16	14	14	14	12	14	10	11	14

Note: Hoist speeds are shown in feet per minute (f.p.m.)

Figure 2-3. Hoist Performance Charts

SECTION III - OPERATION

3-1. GENERAL. Operation of YALE KALC Air Hoists is controlled by a pendant throttle control. The Pendant Throttle Control has a convenient lever type control valve handle (Figure 3-1) suspended from the control manifold.

3-2. PRE-OPERATION CHECKS. Check the following before operating hoist with load:

Check limit stops. Make sure the stop on the tail chain side is securely fastened to the proper link (see chart.)

Type Chain	Size Chain	Number of Chain Links From End Link
Coil	1/4" Wire Dia.	12 Links (9½")
Coil	5/16" Wire Dia.	10 Links (9")

b. When hoist is to be used without a chain container, check that tail chain anchor screw is secure. When hoist is to be used with a chain container, tail chain may be left unattached **PROVIDED LIMIT ACTUATOR IS IN PLACE IN ACCORDANCE WITH ABOVE.**

c. Check to see that limit stop is in proper position.

d. Check hooks. They should not be bent or distorted and should not be opened beyond the correct opening sizes given in Figures 5-5 and 5-6. Hook latches should not be bent or damaged and springs not broken.

e. Check chain to make sure it is not twisted or kinked. Be sure lower block on double reeved models has not been capsized. Be sure load chain is lubricated. See Paragraph 4-3.

f. Check suspension bushing keeper. The keeper must contact a flat on the suspension bushing. Be sure that suspension bushing is screwed in all the way. Be sure screw retaining suspension bushing keeper is tight.

⚠ WARNING
Never operate hoist with defective or missing limit stops, defective hooks or load chain. See Paragraph 5-2 for aid in checking load chain condition.

3-3. OPERATING HOIST. With hoist installed and air pressure turned on, hoist is operated in the following manner:

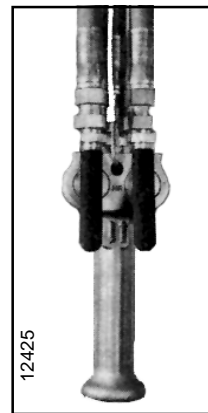

Figure 3-1. Pendant Throttle Control Handle

a. Depress throttle valve lever marked ↑ to raise load. See Figure 3-1.

b. Depress throttle valve lever marked ↓ to lower load.

c. Release lever being depressed to stop either lifting or lowering.

d. Speed of lifting and lowering is varied by the position of the throttle valve lever being depressed.

e. Speed of lowering can be reduced from the maximum by adjusting a screw in the upper fitting of the down valve supply hose.

3-4. UPPER AND LOWER LIMIT STOPS. Upper and lower limit stops are provided to guard against overtravel of load in either raising or lowering direction, which can cause damage to hoist. When highest position is reached, the lower block will cause the overload clutch to slip. When the lowest block position is reached, the tail chain stop will cause the overload clutch to slip. Limit stops are intended as safety devices and should not be used on a routine basis to stop block travel. Lowering full rated capacity load at full rated speed into the limit stop is an especially severe condition and must not be knowingly done at any time.

3-5. MAN-GUARD OVERLOAD CLUTCH OPERATION. The overload clutch is factory preset at assembly so that the hoist will lift its full rated load but will refuse to lift overloads within a range of 110 percent rated load to 200 percent rated load. If the load to be lifted exceeds the clutch factory setting, the motor will continue to run and will rotate the load brake gear without lifting the load. Whenever this occurs, immediately release the "UP" control to prevent overheating of the clutch friction surfaces and motor.

NOTICE

Always know load to be lifted. Loads greater than rated capacity are not to be lifted.

3-6. LOAD CHAIN. Make sure the load chain is lubricated according to the requirements of Paragraph 4-3 before operation. For hoists with stainless steel load chain carefully inspect for unusual chain wear daily during the first week of operation then return to the regular maintenance schedule of Section V.

3-7. PULLING AND PIVOTING HOIST AND LOAD.

- a. The Pendant Throttle Control handle is supported by a strain cable that is suitable for pulling trolley suspended hoists when empty or lightly loaded. Use a tag line or pole to pull or push loads to traverse heavily loaded hoists. Observe caution to stay clear of loads.
- b. To pivot load, push on one corner of load. Lower hook will swivel through 360° to permit load to be swung to the desired position. The upper hook (hook suspension models) is also designed to rotate so that hoist will swing to face the load.

WARNING

Equipment covered herein is not designed or suitable as a power source for lifting or lowering persons.

3-8. OPERATION PRECAUTIONS

Safe operation of an overhead hoist is the operator's responsibility. Listed below are some basic rules that can make an operator aware of dangerous practices to avoid and precautions to take for his own safety and the safety of others. Observances of these rules in addition to frequent examinations and periodic inspection of the equipment may save injury to personnel and damage to equipment.

- a. **Personnel not physical fit or properly qualified, shall not operate hoist.**
- b. **Operate hoist cautiously to become familiar with its performance.**
- c. **Do not lift loads greater than the hoist rated load.**
- d. **Never lift or transport a load until all personnel are clear. Never lift people on hook or load.**
- e. **Stand clear of all loads and never travel loads over people.**
- f. **When lifting load make certain it is free to move and will clear all obstructions.**
- g. **Do not divert attention from load while operating hoist. Never leave a suspended load unattended.**
- h. **Do not operate hoist unless upper and lower limit stops are operating properly.**
- j. **Do not use limit stop as normal operating stop. This is a safety device only.**
- k. **Take up chain slack carefully to avoid jerking load, possibly overloading hoist.**
- l. **Never use hoist chain as a lifting sling around a load or as an electrical ground for welding.**

- m. **Always be sure there is no twist in coil load chain. On 2 & 3 line coil chain hoists, check to see that lower block is not capsized between strands of chain.**
- n. **Avoid operating hoist when hook is not centered under hoist. Be sure that hoist trolley or other support mechanism is correctly positioned for handling the load before lifting.**
- o. **Do not operate hoist with twisted, kinked, badly worn or damaged chain.**
- p. **Do not operate damaged or malfunctioning hoist.**
- q. **Do not "Jog" unnecessarily.**
- r. **Conduct regular visual inspections for signs of damage or wear.**
- s. **Observe recommended inspection and maintenance procedures.**
- t. **Never operate hoist with hooks that have opened up. See Figure 5-5 and 5-6.**
- u. **Do not remove or obscure warning labels.**
- v. **The supporting structure or anchoring means shall have a load rating at least equal to that of the hoist**
- w. **Hoists shall not be used in locations that will not allow operator movement to be free of the load.**
- x. **The operator shall insure that he has firm footing or is otherwise secured before operating the hoist.**
- y. **The load sling or other approved devices shall be seated properly in the saddle of the hook and the hook latch shall be closed before operating hoist.**
- z. **Before lifting a load the operator shall be certain that load is not caught on any obstructions.**
- aa. **When starting to lift or pull, the load should be moved a few inches at which time the hoist should be checked for proper load holding action. The operation shall be continued only after the operator is assured that the hoist is operating properly.**
- ab. **The operator should not leave a loaded hoist unattended at the end of a work shift or for extended periods during the work shift. Where operations are such that this condition cannot be avoided the operator must be assured that the condition does not create a hazard to personnel or property.**
- ac. **Use common sense and best judgment whenever operating a hoist. Observe American National Standard Safety standard, ANSI B30.16, latest issue.**

SECTION IV - LUBRICATION

4-1. GENERAL. The lubrication services outlined in Paragraphs 4-2 through 4-5 should be performed at regular intervals to maintain top hoist performance and insure long life. The frequency for lubrication services will depend on the type of hoisting service that hoist is subjected to and should coincide with periodic preventive maintenance inspection. See Section V - Maintenance.

4-2. SERVICE AIR LINE LUBRICATOR. Servicing air line filter and lubricator unit is of primary importance since it's the only source of lubrication for control valves and air motor. Fill lubricator with a good grade of light spindle oil or air powered tool oil, and follow the manufacturer's recommended service procedure.

4-3. LUBRICATE LOAD CHAIN. A small amount of lubricant will greatly increase load chain life, therefore, chain should not be allowed to run without lubricant. Chain should be cleaned and lubricated as directed in Paragraph a, below. User should set up a regular schedule for chain lubrication after observing operating conditions for a few days.

- a. Under ordinary conditions only weekly attention will be necessary. Under hot and dirty conditions it may be necessary to clean chain at least once a day and lubricate it several times between cleanings. Thoroughly clean chain with an oil solvent and relubricate by coating it lightly with bar and chain oil (LUBRIPLATE or equal). Make sure that lubricant coats wear surfaces between links.
- b. **YALE KALC** spark resistant air hoist models use stainless steel load chain that must be well lubricated at all times and must be inspected daily when in use. See Paragraph 5-2.a.(2).

- b. Apply a few drops of graphite suspension oil on shank of lower hook where it enters lower block. Hook rotation bearing may be removed for cleaning and relubricating if necessary. See Paragraph 7-5.
- c. On lower block assemblies with 2 or 3 lines of load chain also apply a good grade of bearing grease through pressure fitting in end of sprocket pin to lubricate bearing in chain sprocket.
- d. On models with 3 lines of load chain lubricate sprocket in hanger bracket with a few drops of graphite suspension oil in hole provided in center of sprocket hub.

⚠ WARNING

Before performing any internal work on hoist, be certain air is shut off and pressure is released.

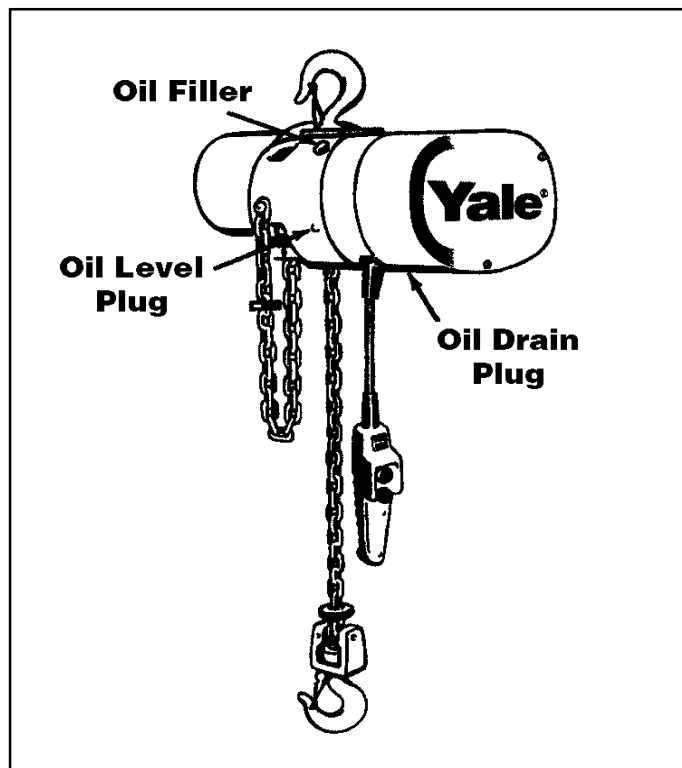

Figure 4-1. Location of Oil Filler and Plugs

4-4. CHANGE GEARCASE OIL (Figure 4-1).

- a. Remove drain plug from bottom of hoist frame and drain oil from gearcase. Replace plug.
- b. Remove oil level plug from side of hoist.
- c. Refill gearcase through oil filler to proper level (bottom of oil level plug hole) using Automatic Transmission Fluid - DEXRON® Type. This is an all weather oil available from all major oil companies. 1-1/2 pints of oil are required.

4-5. LUBRICATE UPPER HOOK AND LOWER BLOCK ASSEMBLY.

- a. Apply a few drops of graphite suspension oil on shank of upper hook where it enters frame.

SECTION V - MAINTENANCE

5-1. GENERAL. Preventive maintenance services required on **YALE KALC** Air Hoists are for the most part, simple periodic inspection procedures to determine condition of hoist components. Below are suggested inspection procedures, based on daily average hoist usage.

5-2. THIRTY DAY INSPECTION. Hoist may be left suspended.

- a. Inspect Load Chain.
 - (1) Operate hoist under load and observe operation of chain over sprocket in both directions of chain travel. Chain should feed smoothly into and away from the sprocket. If chain binds, jumps or is noisy, first see that it is clean and properly lubricated. If trouble persists, inspect chain as outlined below.
 - (2) Clean chain for inspection. Examine visually for gouges, nicks, weld splatter, corrosion or distorted links. Slacken chain and check bearing surfaces between links for wear, Figure 5-1. Greatest wear will often occur at sprocket at high or low point of lift, particularly when hoist is subjected to repetitive lifting cycles. Case hardness of chain is about .015" deep. Chain must be replaced before the case is worn through. Also check chain for elongation using a vernier caliper (Figure 5-2). Select an unworn, un-stretched section of chain (usually at slack or tail end) and measure and record the length over the number of chain links (pitches) indicated in Figure 5-2. Measure and record the same length of a worn section in the load side of the chain. Obtain the amount of wear by subtracting the measurement of the unworn section from the measurement of the worn section. If the result (amount of wear) is greater than the amount specified in the "ALLOWABLE CHAIN WEAR" table, the chain has elongated beyond the maximum allowable length and must be replaced. Chain with excessively pitted, corroded, nicked, gouged, twisted or worn links should be replaced using only factory approved chain. **Never weld or attempt to repair coil chain.**

Load chain for spark resistant models is made of stainless steel. Surface hardness treatment is no more than .001" deep and the core is lower in hardness

than standard alloy steel load chain. For these reasons the rated capacity of spark resistant models is lower than that of standard models as follows:

Lines of Load Chain	Rated Capacity For Standard Model (tons)	Rated Capacity For Spark Resistant Model (tons)
1	1	1/2
2	2	1
3	3	2

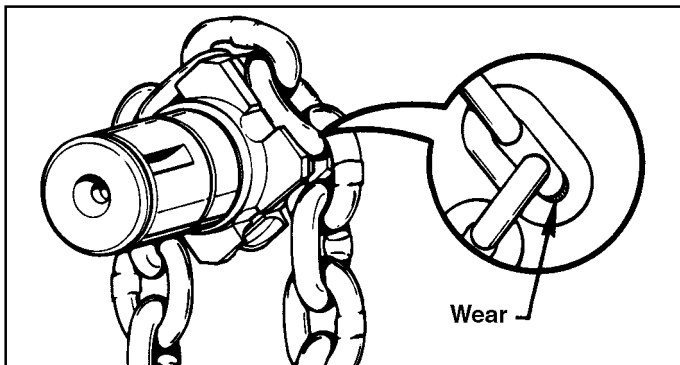

Figure 5-1. Check Chain Wear at Bearing Surfaces Between Links

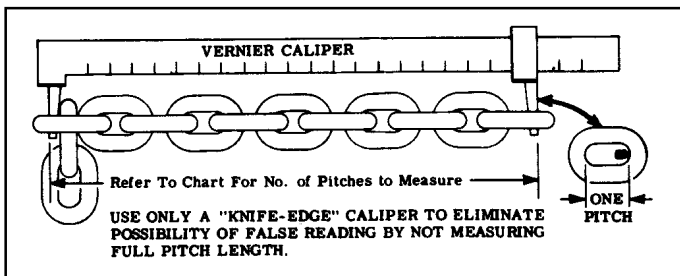

Figure 5-2. Check Coil Chain Using Vernier Caliper

ALLOWABLE CHAIN WEAR - ELONGATION

Chain Size (wire dia.)	No. of Pitches to Measure	Maximum Wear Limit
5/16"	11	.142"

⚠ WARNING

Do not assume that load chain is safe because it measures below replacement points given herein. Other factors, such as those mentioned in visual checks above, may render chain unsafe or ready for replacement long before elongation replacement is necessary.

⚠ WARNING

When replacing coil load chain, use only factory approved chain conforming to factory specifications for material, hardness, strength and link dimensions. Chain not conforming to YALE hoist specifications may be dangerous as it will not fit in the load sprocket and chain guide correctly, causing damage to hoist, and it will wear prematurely, deform and eventually break.

(3) Removing and Replacing Coil Load Chain.

- (a) Replacement coil load chain is installed by attaching it to tail end of old chain, after disconnecting old chain from side of hoist frame and removing limit stop. New chain is then run into hoist as old chain is run out. Use open "C" links, Figures 5-3 and 5-4, for attaching chains. Links must be identical in size to hoist chain - 5/16" wire size with .858" pitch length for all models. Be certain that all welds on links of replacement chain face away from center of load sprocket.
- (b) Remove lower block assembly and actuator from old chain and attach them to replacement chain at end which was just run through hoist. Install limit stop (as noted below) on other end of chain and anchor chain to side of hoist frame.

NOTICE

Use one or two "C" links to orient chain for chain anchor screw. Position first link of new chain to be flat against hoist housing without twisting the chain.

Note: Install limit stop as shown in chart on page 5.

On double line models, also connect opposite end of chain (from lower block) to load chain anchor inside of frame. On triple line models, the opposite end of the chain is attached to the lower block connecting link.

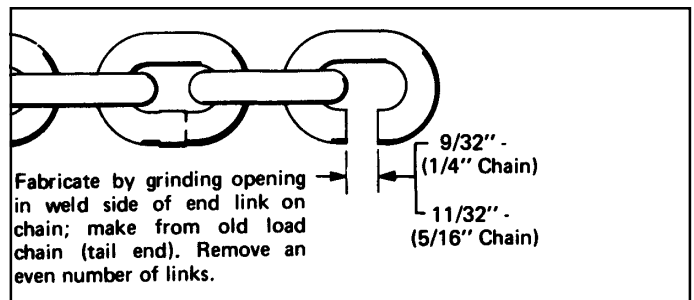

Figure 5-3. Open "C" Link for Removing and Installing Link Load Chain



Figure 5-4. Installing Coil Load Chain Using Two "C" Links (1/4, 1/2 & 1 ton hoists)

Note: In the event the old chain is to be removed from the hoist and reinstalled, a short length of chain (about 18" long) must be run into hoist when the old chain is removed. This short length can then be used in the same manner as shown in Paragraph 5-2.a(3). Be sure to use the proper number of open "C" links in order to correctly position end link on tail end of chain to fit anchor at side of hoist frame.

NOTICE

When installing coil load chain do not attempt to hand feed chain into hoist, or use a piece of wire in place of the method described herein. To do so may result in serious internal damage to hoist, as coil chain links must be properly seated in chain sprocket before chain is run into hoist.

- (4) Check connection of chain to lower block on single reeved and triple reeved hoists. Replace parts showing evidence of damage, twisting or elongation.
- (5) Check connection of chain to anchor inside hoist frame on double-reeved hoists. Replace parts showing evidence of damage, twisting or elongation. (Also see Section VII, Paragraph 7-2.a.(2).
- (6) Lubricate load chain before using hoist. See Paragraph 4-3, Section IV.

b. Inspect Lower Block.

- (1) Check for bent or distorted hook. If hook is opened beyond the dimension given in Figure 5-5, it must be replaced. Also check to see that hook swivels and is free to pivot. Lubricate these points if necessary.

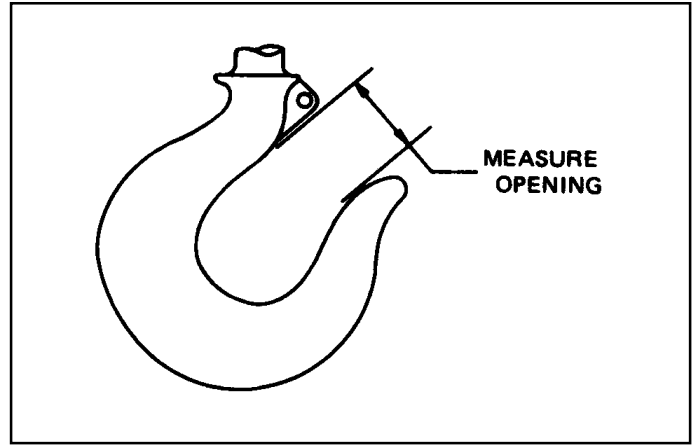

Hoist Capacity (tons)		Hook Throat Opening	
		Normal Opening	Replace Hook If Opening is Greater than
Std.	S.R.		
1	1/2	1-1/4	1-7/16
2	1	1-3/8	1-9/16
3	2	1-1/2	1-11/16

Figure 5-5. Lower Hook Opening (Shown with latch removed for clarity.)

- (2) On double and triple reeved hoists, check sprocket and bearing in lower block for freedom of movement and signs of damage. Lubricate if necessary. Replace damaged parts.
- (3) Check hook latches. Replace damaged or bent latches or broken springs.

⚠ WARNING

Hooks, upper or lower, damaged from chemicals, deformation or cracks or having more than 15 percent in excess of normal throat opening or more than 10 degrees twist from the plane of the unbent hook, or opened, allowing the hook latch to bypass hook tip must be replaced.

Any hook that is twisted or has excessive throat opening indicates abuse or overloading of the hoist. Other load bearing components of the hoist should be inspected for damage. (See Section V, Paragraph 5-2.d.(2) below).

c. Inspect Upper Suspension.

⚠ WARNING

All models utilize an upper suspension bushing to attach the upper suspension to the hoist frame. The bushing must be threaded all the way into the frame, and the keeper must contact a flat on the suspension bushing. The suspension bushing keeper screw must be kept tight. Failure to do so could result in the suspension separating from the hoist.

- (1) On hook suspended models, check for bent or distorted hook. If hook is opened beyond the dimension given in Figure 5-6, it must be replaced. Also check to see that hook pivots. Lubricate if necessary. Single reeved hoists have a stop pin installed in frame adjacent to hook to restrict hook rotation. Check to see that pin is not sheared off and stop lug on hook shank is not broken.

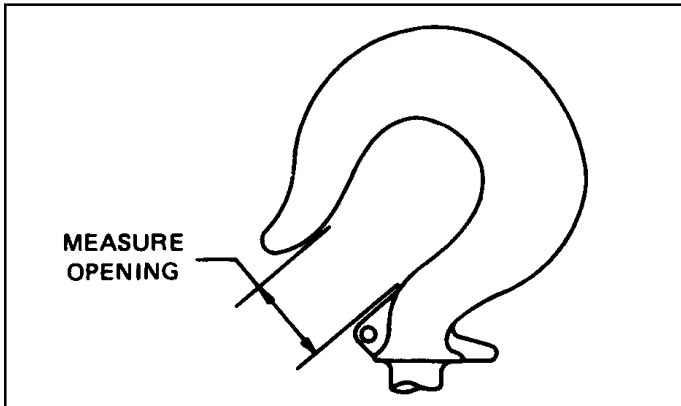

Hoist Capacity (tons)		Hook Throat Opening	
		Normal Opening	Replace Hook If Opening is Greater than
Std.	S.R.		
1	1/2	1-1/4	1-7/16
2	1	1-3/8	1-9/16
3	2	1-1/2	1-11/16

Figure 5-6. Upper Hook Opening (Shown with latch removed for clarity.)

- (2) On lug suspended models, check condition of suspension lug. Replace lug if damaged or cracked. Check to see that lock plate is in place on lug and screw holding it is tight.
 - (3) On double reeved hoists, check to see that upper lock plate securing hook or lug bushing is in place and screws holding it are tight. Lubricate hook shank.
 - (4) Check hook latch. Replace damaged or broken parts.
 - (5) Check suspension bushing, keeper and screw, make sure bushing is screwed in all the way and keeper screw is tight.
- d. Inspect Motor and Frame.
- (1) Check to see that bolts securing motor to frame are tight. Also check for any visible damage to motor, supply head or muffler, such as a cracked or dented housing. Replace damaged parts.
 - (2) Check hoist frame for signs of visible damage. If frame shows evidence of fracture, the hoist should be disassembled and inspected for further signs of damage from possible overloading. Replace damaged parts. Also check condition of limit stop.
- e. Check Oil Level. Remove oil level plug (Figure 4-1). If oil level is not even with bottom of tapped hole, add Automatic Transmission Fluid, DEXTRON® Type, to bring proper level.

5-3. SIX-MONTH INSPECTION OR 500-750 HOURS OF OPERATION. Hoist may be left suspended.

- a. Check control cable wire strain reliever to see that it is in good condition and securely attached to supply head assembly.
- b. Change Gearcase Oil. See Section IV, Paragraph 4-4.
- c. Relubricate Load Chain. See Section IV, Paragraph 4-3.
- d. Lubricate Upper Hook and Lower Block. See Section IV, Paragraph 4-5.

5-4. ANNUAL INSPECTION. Hoist must be disconnected from air service and removed from overhead suspension. **Hoists subjected to severe service or to adverse environments should be examined weekly or as conditions warrant.**

- a. Hoist should be partially disassembled as necessary to inspect hoist parts noted in Paragraphs b through e below. Refer to Section VII for disassembly and reassembly steps as noted.
- b. Inspect Pendant Throttle Control Assembly. Remove springs and valves (Paragraphs 7-6.a.(3) through 7-6.a.(5)). Check condition of springs and valves. Replace worn or damaged parts.
- c. Inspect Supply Head Assembly. Remove supply head assembly (Paragraph 7-7.a) and disassemble it as outlined. Check condition of valves. Replace worn or damaged parts.
- d. Inspect Air Motor. Remove air motor assembly (Paragraph 7-2.d) and disassemble it as outline (Paragraph 7-8). Check for worn or damaged rotor vanes. Inspect ball bearings and check condition of rotor, shaft, cylinder and end plates. Any repairs beyond replacing vanes, springs, and pins would best be done at an authorized **YALE** repair station. Repair or replace defective parts as noted in following steps:
 - (1) Rotor. Examine end faces for roughness and vane slots for wear and burrs. A new vane should move in and out without binding. Smooth roughness on end faces and remove sharp edges or burrs at slot corners using a hone. Replace motor if rotor and shaft assembly is excessively worn or damaged.
 - (2) Cylinder. Examine surface of bore diameter for rough circular grooves from scoring. If the cylinder is badly scored, it must be replaced. A badly scored cylinder cannot be restored by honing, since it will only enlarge bore diameter, widening seal point between rotor and cylinder, resulting in loss of speed and power. If cylinder is replaced, new shim gaskets of the proper thickness are required to maintain the original spacing of the end plates.
 - (3) End Plates. Check faces of front and rear end plates for wear of scoring. If wear depth is greater than .005 inch, end plates should be replaced. Light score marks can be lapped out with 150-grit abrasive cloth on a flat surface.
 - (4) Rotor Vanes and Springs. Inspect the rotor vanes for wear, scoring, warpage, or other damage. Compare the width of the old vane with a new one to determine the amount of wear that has taken place on the width.

SECTION VI - TROUBLE SHOOTING

Trouble	Probable Cause	Remedy
6-1. Hoist does not operate.	<ol style="list-style-type: none"> 1. Insufficient air pressure at source. 2. Insufficient air supply at hoist. 3. Clogged air intake. 4. Excessive overload. 5. Clogged valve - pendant throttle throttle control. 6. Clogged or inoperative valve-supply head assembly. 7. Motor failure. 	<ol style="list-style-type: none"> 1. Check air pressure and adjust. 2. Use correct size supply hose. 3. Shut off air - disconnect air hose - clean air filter. 4. Reduce loading to rated capacity of hoist, as shown on nameplate. 5. Disassemble and check pendant control. Refer to Section VII, Paragraph 7-6. 6. Disassemble and check supply head assembly, Refer to Section VII, Paragraph 7-7. 7. Disassemble motor and check rotor vanes and springs. Replace defective parts.
6-2. Hoist will not hold load in suspension.	<ol style="list-style-type: none"> 1. Load brake not holding. 	<ol style="list-style-type: none"> 1. Remove load brake and inspect parts. Refer to Section VII, Paragraph 7-4.
6-3. Hook Will Raise But Not Lower.	<ol style="list-style-type: none"> 1. Load brake locked up and overload clutch slipping (Caused by excessive overload). 	<ol style="list-style-type: none"> 1. Consult Authorized YALE Hoist Repair Station.
6-4. Hoist loses power.	<ol style="list-style-type: none"> 1. Insufficient air pressure. 2. Clogged air intake. 3. Clogged muffler (Iced). 4. Worn or broken rotor vanes, springs or pins. 	<ol style="list-style-type: none"> 1. Check air pressure and adjust. 2. See this Section, Paragraph 6-1. 3. Remove muffler cover. Clean screen and muffler. Reduce frequency of lift to prevent icing. 4. Replace rotor vanes, springs, and pins.
6-5. Cannot regulate speed by control handles.	<ol style="list-style-type: none"> 1. Clogged valve - pendant throttle control. 	<ol style="list-style-type: none"> 1. See this section, Paragraph 6-1.
6-6. Hoist lifting or lowering speed differs from rated speed at full load.	<ol style="list-style-type: none"> 1. Incorrect air pressure or inadequate air supply. 2. Loss of power. 	<ol style="list-style-type: none"> 1. Check pressure at hoist when hoist is operating. 2. See this section, Paragraph 6-4.

SECTION VII - DISASSEMBLY AND REASSEMBLY

7-1. GENERAL.

- a. The following disassembly and reassembly instructions apply to all models of **YALE KALC** Air Hoists. Where needed, variations to instructions are provided to cover differences between models (suspensions, load chain, reeving, capacity sizes) with applicable models specifically noted.
- b. A complete tear down procedure is given. However, if only certain parts require repair or replacement, a partial tear down may be performed, using applicable portions of the instructions.
- c. For easier handling during disassembly, the following disassembly steps may, where conditions permit, be completed before hoist is removed from its overhead suspension or disconnected from its air supply: Remove chain container, if hoist is so equipped. Remove lower block and load chain assembly, following procedure outlined in Paragraph 7-2.a. Drain and discard gearcase oil, by removing plug at bottom of frame.
- d. These hoists contain precision machined parts and should be handled with care at disassembly and at reassembly. When removing or installing parts with press fits, be careful to apply pressure evenly. On ball bearings, apply pressure to face of inner or outer race, whichever is adjacent to mating part. This will avoid damage to bearing races from brinelling by pressing through bearing balls.

Apply a thin film of sealant to parts having a press fit when they are installed.

- e. To remove hoist from overhead suspension:
 - (1) Turn off air at source.
 - (2) Operate control to bleed air from hoist.
 - (3) Disconnect air hose at inlet swivel.
 - (4) Remove hoist from overhead suspension.

7-2. DISASSEMBLY OF HOIST INTO SUBASSEMBLIES.

- a. Removal of Lower Block and Load Chain Subassembly.
 - (1) On models with single reeved load chains disconnect tail end of load chain from anchor at side of frame. Remove fillister head screw holding end link to frame. Remove screws and lockwashers from the limit stop and remove from chain. With hoist connected to air supply, run chain out of hoist by operating in "lowering" direction. (See note following Paragraph (2) below and note in Section V, Paragraph 5-2.a.(3) for inserting short length of chain.)
 - (2) On models with double reeved load chains disconnect tail end of load chain from anchor at side of hoist frame and remove limit stop as in (1) above, run chain out of hoist by operating it in "lowering" direction, and disconnect opposite end of load chain from anchor inside hoist frame. To disconnect this end of chain, remove cotter pin from end of anchor pin, press pin from anchor and withdraw chain.

Note: If hoist is inoperative it will be necessary to wait until after load brake is removed (Paragraph c, below),

then the chain can be pulled through the hoist by hand.

- (3) On triple reeved chain hoists, remove retaining ring and connecting link pin as shown in Figures 7-27 and 7-28. Remove connecting link with chain from lower block. To remove connecting link from chain, take out cotter key and push anchor pin from connecting link. Chain can now be pulled through hanger bracket and lower block. Unfasten tail chain from hoist frame, remove limit stop, and if air is available, operate hoist in lowering direction to remove chain. (See note in Section V, Paragraph 5-2.a.(3) for inserting short length of chain.) If hoist is inoperative see note below but be sure to install short length of chain into hoist before removing load chain.

Note: If hoist is inoperative it will be necessary to remove load brake (Paragraph c, below) so chain can be pulled through the hoist by hand.

- (4) To remove hanger bracket from triple reeved hoist, remove retaining ring and connecting rod pin (see Figure 7-1). Rotate hoist approximately 45° (see Figure 7-2) and hanger will slip free from hoist frame.

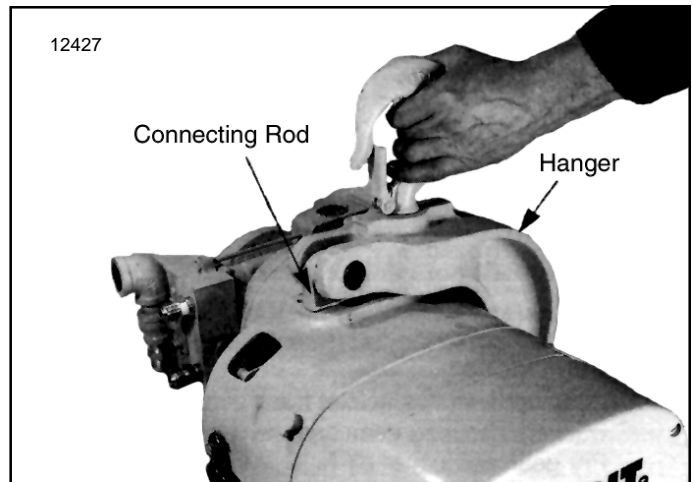

Figure 7-1. 3 Ton Hanger Bracket Connection Pin Removed

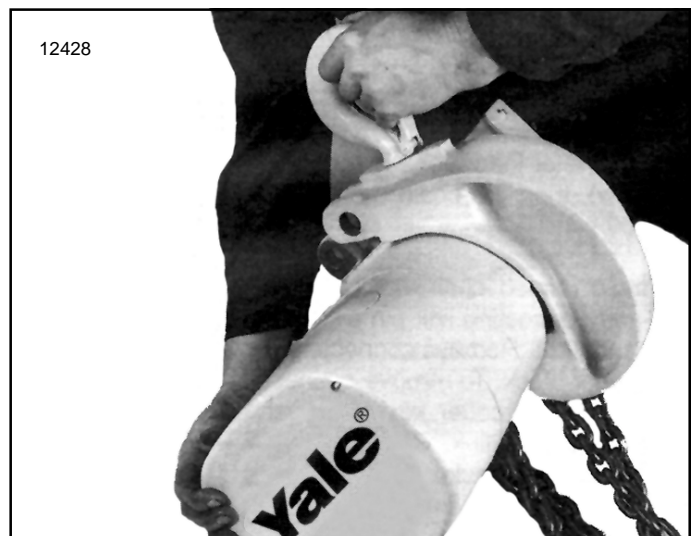

Figure 7-2. Removing 3 Ton Hanger Bracket from Hoist Frame

b. Removal of Counterweighted Compartment Cover and Gearcase Subassembly.

(1) Disconnect hoist from air source. Remove three cover retaining screws and lift off cover (Figure 7-3). Cover screws have retaining rings which hold them in cover. Use caution as cover contains a counterweight.

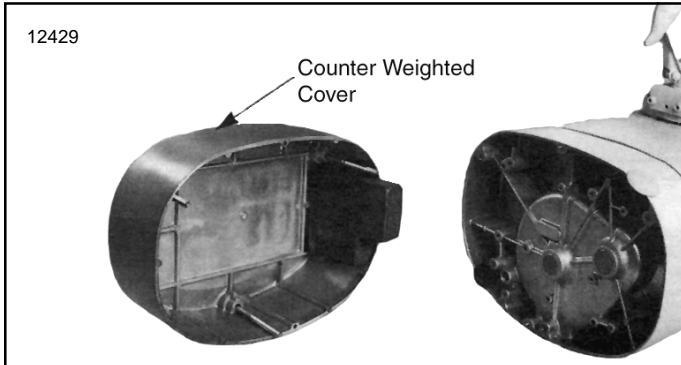

Figure 7-3. View of Hoist with Counterweighted Compartment Cover Removed

(2) Remove eight hex socket head screws and lockwashers securing gearcase cover to hoist frame. Pry gearcase cover off hoist frame using screwdriver at special notches provided at opposite corners of cover (Figure 7-4). Gearcase cover can now be lifted from frame (Figure 7-5). Discard gearcase cover gasket.

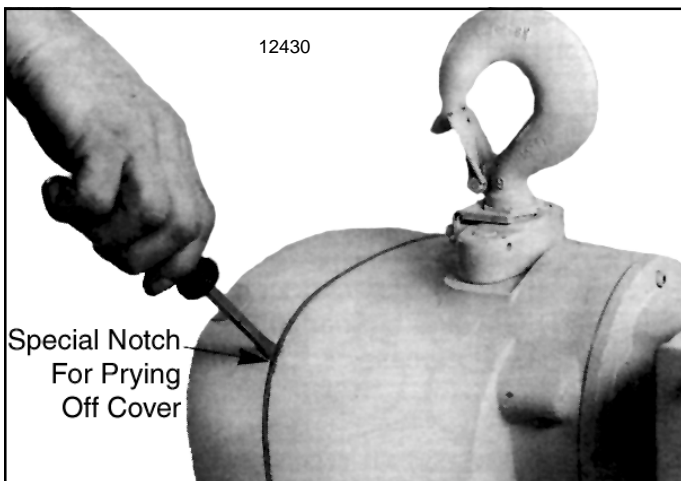

Figure 7-4. Prying Gearcase Cover From Hoist Frame

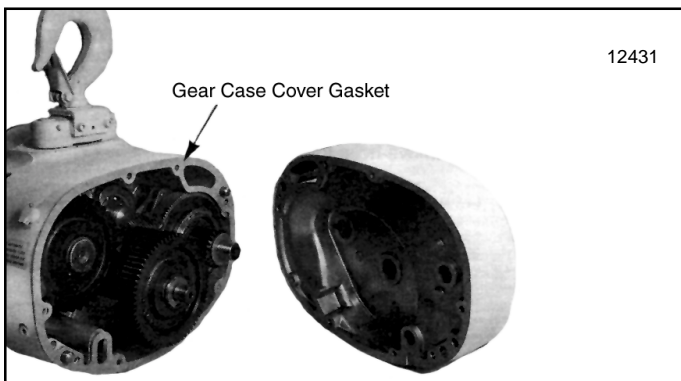

Figure 7-5. Gearcase Cover Removed From Hoist Frame

c. Removal of Load Brake and Clutch Assembly and Intermediate Gear Subassembly.

Pull load brake and clutch assembly and intermediate gear assembly, including the thrust washers for each unit, from hoist frame (Figure 7-7).

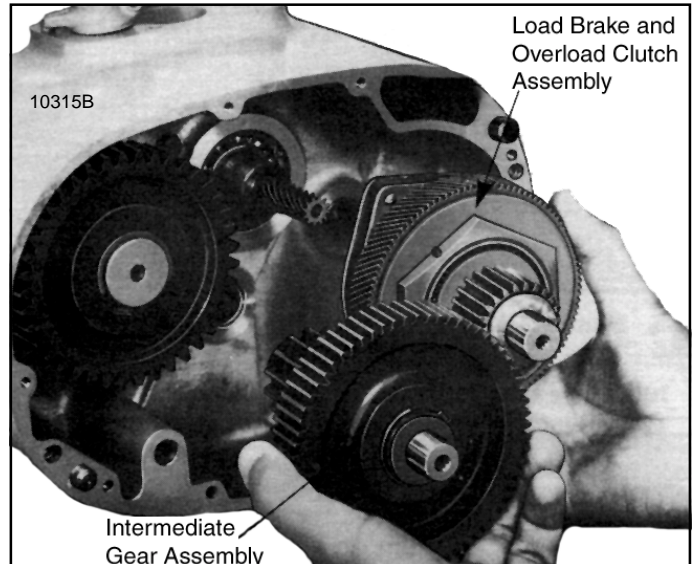

Figure 7-7. Removing Load Brake and Clutch and Intermediate Gear Subassemblies

d. Removal of Motor and Supply Head Assembly.

Place hoist frame on wood blocks to protect integral gear on motor shaft. Loosen four motor mounting bolts and lift motor assembly from frame (Figure 7-8).



Figure 7-8. Removing Motor Assembly

7-3. REBUILD OF HOIST FRAME, SPROCKET GEAR, SPROCKET SHAFT AND CHAIN GUIDE

a. Disassembly of Sprocket Gear, Shaft and Chain Guide.

- (1) Remove retaining ring from end of sprocket shaft and pull off sprocket gear using a common puller (Figure 7-9). Remove Woodruff key from shaft.



Figure 7-9. Pulling Sprocket Gear from Sprocket Shaft Using Common Puller

- (2) Unscrew four fillister head machine screws securing sprocket bearing retaining plate and remove plate (Figure 7-10). Remove and discard ring gasket from groove around bearing or remove seal disk.

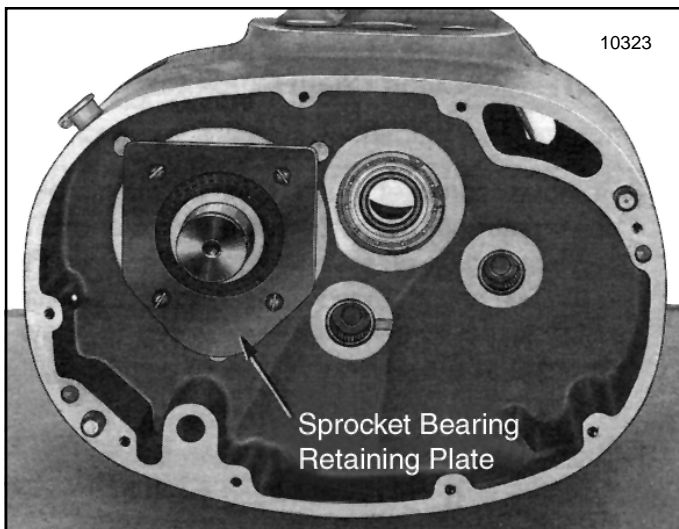

Figure 7-10. View of Sprocket Bearing Retaining Plate

- (3) Remove "C" clips holding chain guide pins in place. Pull guide pins out from motor side of frame. (Fig 7-12)



Figure 7-12. Removing Chain Guide Support Pins

- (4) Remove sprocket shaft and front ball bearing assembly from frame by lifting up on end of shaft while prying up on sprocket as illustrated in Figure 7-13. The chain guide will need to be repositioned in frame as sprocket shaft is raised to allow the sprocket to pass through hole of guide (Figure 7-14).

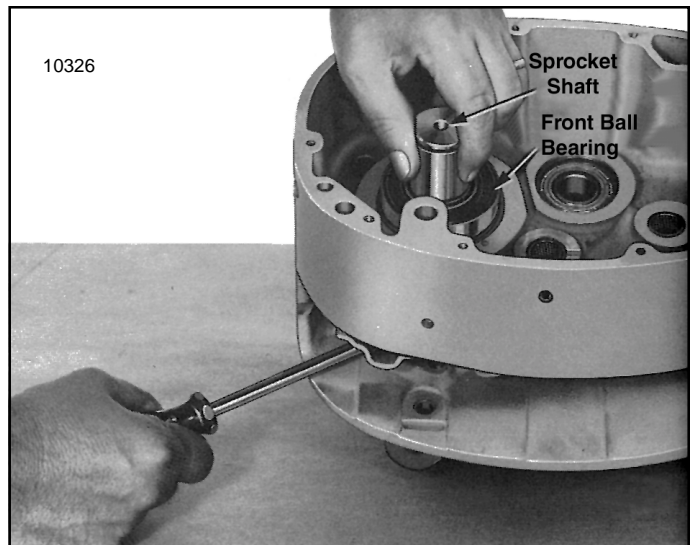

Figure 7-13. Removing Sprocket Shaft and Front Bearing

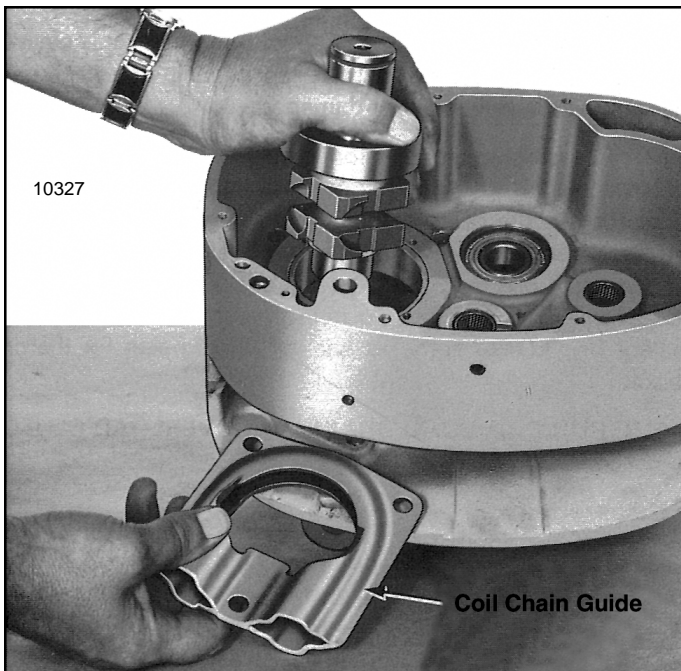

Figure 7-14. Chain Guide Being Removed From Frame as Sprocket Shaft is Lifted Out

Note: Do not remove oil seal, ball bearings, and needle bearings from their bores in the frame unless they show evidence of wear or damage and require replacement. When replacing rear sprocket ball bearing pack bearing 1/2 full with NLGI No. 2 grease.

b. Disassembly of Upper Hook (Hook Suspension Models.)

- (1) On 1/4 through 1 ton models, remove screw securing suspension bushing keeper. Unscrew suspension bushing from frame to remove hook.



Figure 7-15. Removing Upper Hook and Hook Nut from Hoist Frame (1/4 through 1 Ton Models)

- (2) On double reeved models, unscrew two hex socket head screws holding suspension bushing lock assembly to upper block (Figure 7-16) and remove lock. Unscrew suspension bushing from block to

remove hook. To disassemble block from frame remove drive pin from nut inside frame and unscrew nut from stud holding body to frame. Remove drive pin securing threaded end of chain anchor in block and unscrew anchor. Block can then be lifted off.



Figure 7-16. View of Upper Hook Assembled to Hoist Frame (Double Reeved Models)

Note: Hook and bushing assembly is not to be further disassembled as nut securing bushing to hook shank is welded in place at the factory. Only the assembly is available for replacement.

- (3) On tripled reeved models, remove retaining ring from connecting rod pin and push connecting rod pin through bracket and connecting rod, releasing hanger (see Figure 7-1). Raise hanger above hoist frame to provide access to hook nut. Rotate hook until grooved pin in nut is visible from end of hanger frame. Using a drift punch, drive grooved pin through hook nut until it hits hanger pocket. Remove drift punch far enough to hold nut from turning and unscrew hook from nut. Thrust washer will fall free.
- (4) To remove connecting rod (fig 7-2) on 3 ton hoist, remove screw securing suspension bushing keeper. Unscrew suspension bushing to remove connecting rod from frame.

c. Disassembly of Suspension Lug (Lug Suspension Models).

- (1) On 1/4 through 1 ton models, remove two screws securing anti-rotation bracket and remove bracket. Remove screw securing suspension bushing keeper, and remove keeper. Remove suspension lug using an extra thin 1-1/4" open end wrench to unscrew suspension bushing from frame. (See fig. 7-17).

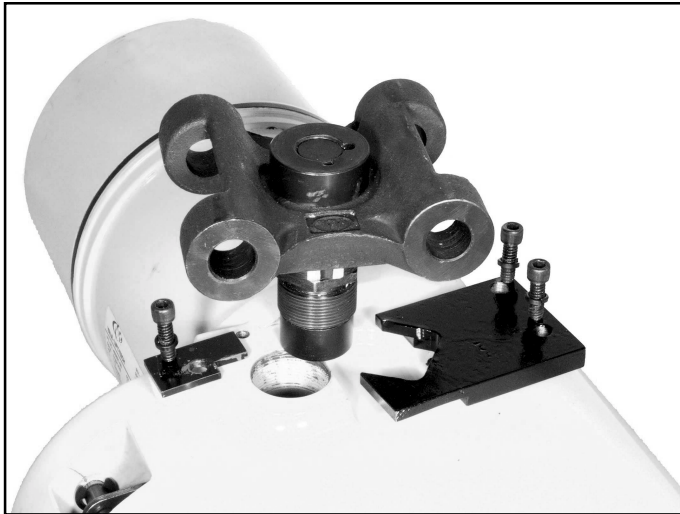

Figure 7-17. Removing Suspension Lug
(1/4 through 1 Ton Models)

- (2) On 2 ton models, remove three hex socket head screws securing the two lock plates to block at top of frame and pull out locks. Remove suspension lug, using an extra thin 1-1/4" open end wrench to unscrew suspension bushing from block. Instructions for removing block from frame are given in paragraph b. (2).

NOTE: The suspension lug is not to be further disassembled, as nut securing suspension bolt and bushing to lug is permanently secured in place at the factory. Only the suspension lug assembly is available for replacement.

- (3) On 3 ton models lug bolt is removed in same manner as hook. See paragraph 7-3. b. (3).

d. Reassembly.

- (1) Before assembly, all parts should be thoroughly cleaned and inspected to determine their serviceability. Replace parts that are excessively worn or damaged.
- (2) Reassemble suspension hook or lug, chain guide, sprocket shaft and sprocket gear to frame following a reverse procedure of the disassembly steps listed in Paragraphs a through c, above. If ball bearing is to be reinstalled on sprocket be certain to position it so that the seal side of bearing faces out, away from sprocket. To help prevent oil seepage, apply sealant on O.D. of sprocket bearing and in seat for the ring gasket.

▲WARNING

If groove pin securing nut to upper hook is loose, replace hook-nut assembly and pin.

7-4. REBUILD OF LOAD BRAKE AND OVERLOAD CLUTCH ASSEMBLY

a. Disassembly.

- (1) Place load brake and clutch assembly, flange up, in a vise equipped with brass or copper jaw plates to protect pinion gear teeth. Remove snap ring from end of load brake shaft (Figure 7-18).

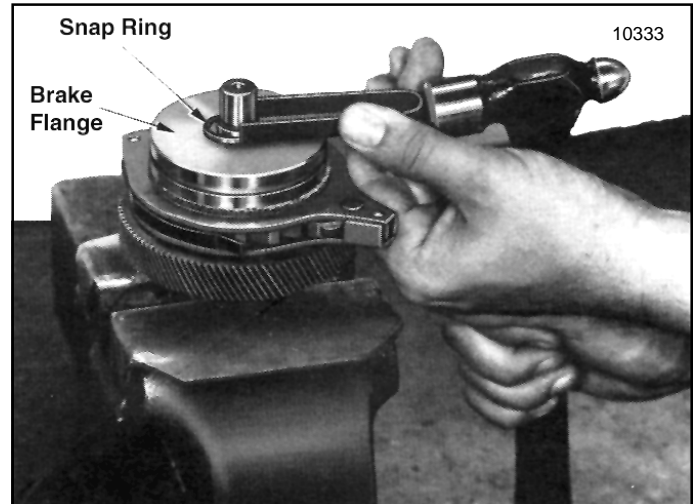

Figure 7-18. Removing Snap Ring from Load Brake Shaft

- (2) Using a puller tool, remove brake flange from shaft. A groove is provided around outer diameter for this purpose. See Figure 7-19. Remove key from shaft and lift off 2 friction discs, and the pawl and ratchet assembly (Figure 7-20).

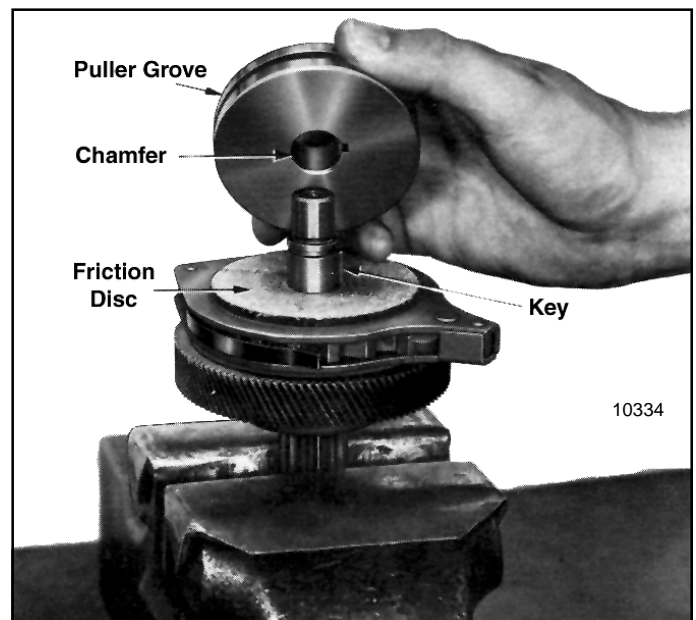

Figure 7-19. View Showing Load Brake Flange Removed

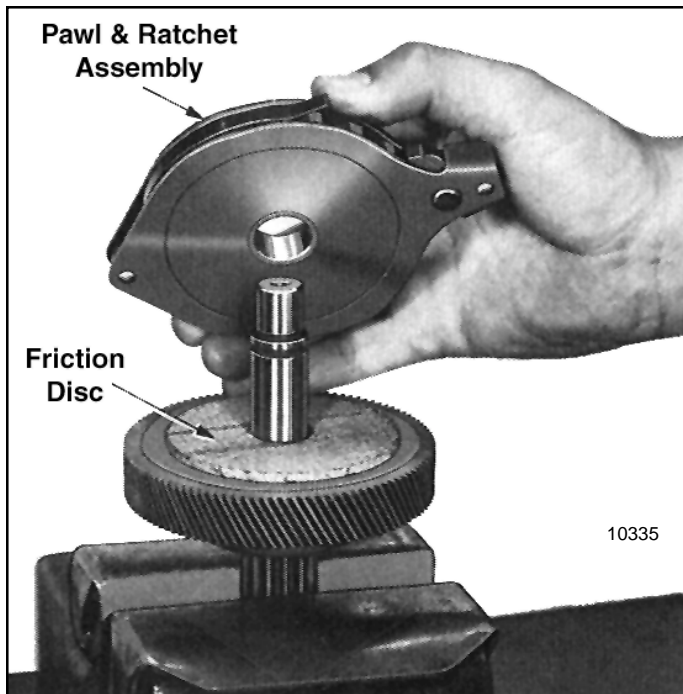

Figure 7-20. Removing Pawl and Ratchet Assembly From Load Brake Shaft

- (3) Remove load brake gear and overload clutch assembly from output pinion shaft. Pull the spring from its recess in clutch cone (Figure 7-21) but do not further disassemble gear and clutch assembly. See "Note" below.

Note: Disassembly of the load brake gear and overload clutch assembly (Figure 7-21) is not recommended. Clutch pressure is preset by the factory at assembly to provide the correct torque to allow the clutch to refuse loads within a specified range (110% of rated load to 180% rated load). It is suggested whenever there is a need to repair or readjust the gear and clutch assembly that it be sent to an authorized **YALE** Hoist Repair Station where adequate tools, fixtures and appropriate test equipment is available.

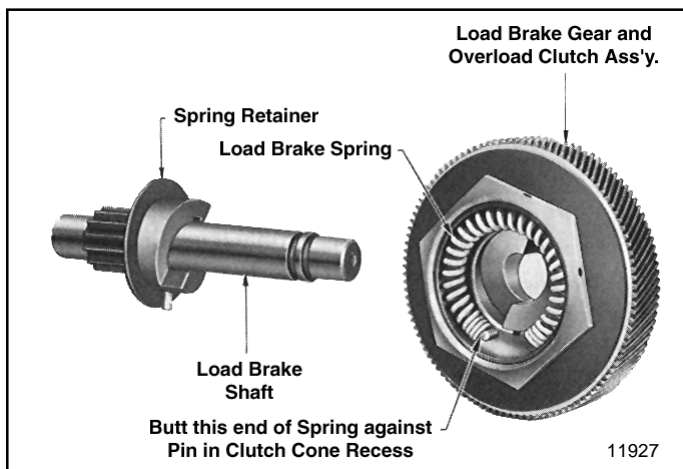

Figure 7-21. Load Brake Gear and Overload Clutch Assembly Removed from Load Brake Shaft Showing Brake Spring Installed in Clutch Cone

- (4) The load brake pawl and ratchet is a riveted assembly and is not to be disassembled.
- b. Reassembly.
- (1) Before assembly, all parts should be cleaned and inspected to determine their serviceability. Replace parts that are excessively worn or damaged.
 - (2) Reassemble load brake parts following a reverse procedure of the disassembly steps listed above, observing the assembly steps (3) through (6) below.
 - (3) Before installing spring in its recess in center of clutch cone (Figure 7-21) apply a good grade of ball bearing grease to inside of recess. Spring must be positioned exactly as illustrated, butted against pin.
 - (4) When installing pawl and ratchet assembly on load brake shaft, be certain that teeth on ratchet face are in the same direction as shown in Figure 7-20. The ratchet assembly should rotate freely when turned counterclockwise and the pawl should engage ratchet teeth when unit is turned clockwise.
 - (5) When installing brake flange position it with chamfer facing friction disc, Figure 7-19.
 - (6) The brake spring must be pre-loaded at assembly to a torque of from 10 to 14 lb. ft. This is accomplished using a plumber's strap wrench to wind (rotate) load brake gear to set up spring (Figure 7-22) while pressing brake flange into place using an arbor press. Clamp pinion end of shaft into a portable vise to keep brake from rotating in press. Use brass or copper jaw plates on vise to protect pinion gear teeth. Wind gear counterclockwise (viewing brake from flange end) with plumber's strap wrench and press down on flange until snap ring groove in shaft is exposed allowing snap ring to be installed. Use extreme care not to over wind spring as yield will result and final spring torque will be reduced. Do not wind gear beyond point necessary to install snap *ring in groove.

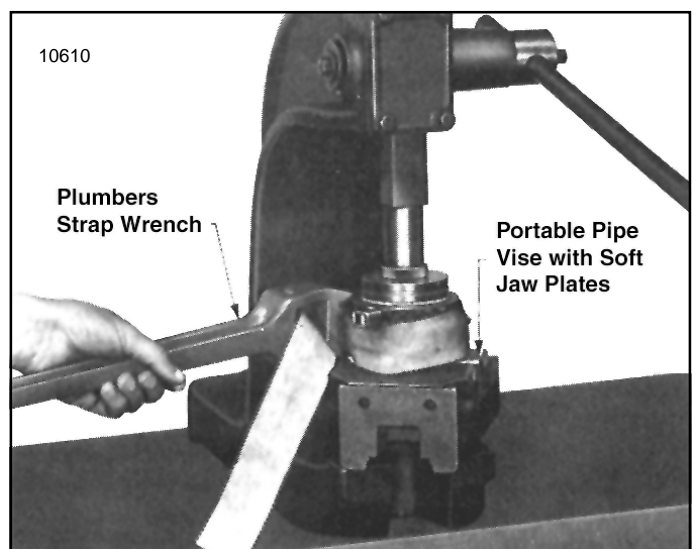

Figure 7-22. Winding Load Brake Gear Using a Plumber's Strap Wrench to Set Up Load Brake Spring.

7-5. REBUILD OF LOWER BLOCK AND LOAD CHAIN ASSEMBLY

a. Disassembly (single reeved models).

- (1) Separate load chain from lower block assembly. Drive out small roll pin securing lower block pin in lower block yoke and push lower block pin from yoke to release chain.
- (2) Unbolt and remove limit actuator(s). On a single line hoist that has a bumper, remove the bumper also.
- (3) Lower blocks are of a pinned construction, permitting replacement of body, thrust bearing, or hook and nut assembly. To disassemble, drive spring pin from hook nut (Figure 7-23). With pin removed, hold hook nut from turning with drift punch and rotate hook to unscrew it from nut. Separate hook, bearing shield, needle bearing and two thrust washers from body. Hook and nut are drilled at assembly and are replaced only as an assembly.



Figure 7-23. Removing Roll Pin Securing Hook Nut to Hook Shank

b. Disassembly (double reeved models).

- (1) On double reeved models, remove fillister head screw securing center guide in top of lower block body and lift out guide (Figure 7-24) and sprocket pin lock (Figure 7-25). Press sprocket pin from body and pull out chain, sprocket and washer (Figure 7-26). Do not remove bushing type bearing from sprocket or pressure lube fitting from sprocket pin unless replacement is necessary.



Figure 7-24. Removing Chain Center Guide from Double and Triple Reeved Lower Block Assembly

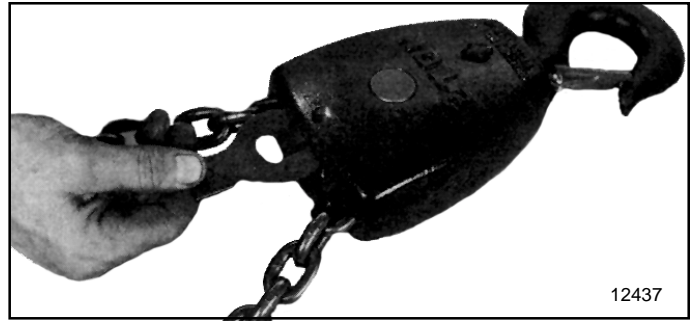

Figure 7-25. Removing Sprocket Pin Lock on Double and Triple Reeved Lower Block Assembly.

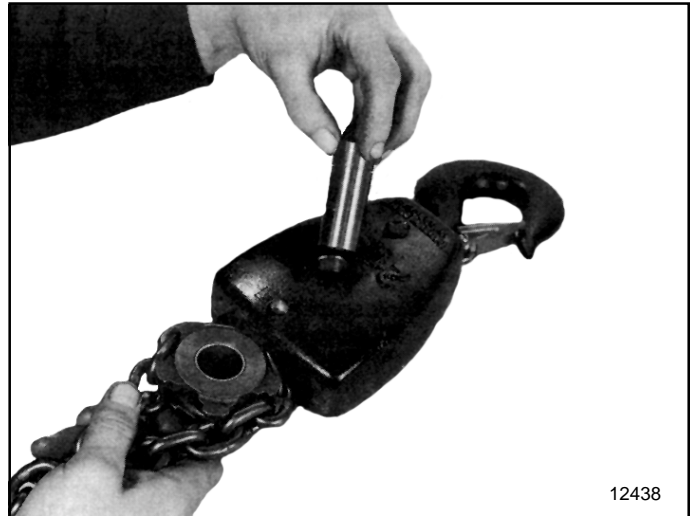

Figure 7-26. Removing Coil Chain and Sprocket on Double and Triple Reeved Lower Block Assembly

c. Disassembly (triple reeved models).

- (2) To remove hook, drive grooved pin from hook nut with drift punch. With pin removed, hold hook nut from turning with drift punch and rotate hook to unscrew it from nut. Separate hook, nut, bearing shield, needle bearing two thrust washers from body. Hook and nut are drilled at assembly and are replaced only as an assembly.
- (1) Remove chain sprocket from lower block following procedure for double reeved models described in Paragraph 7-5.b.(1) above.
- (2) To disconnect end of chain anchored to lower block, remove retaining ring from pin bore (Figure 7-27). Push connecting link pin from bore by pressing through hole provided in opposite side of block (Figure 7-28). Chain connecting link is now free and can be further disassembled for inspection.
- (3) To remove hook from lower block body, first drive grooved pin from hook nut. Then hold nut from turning using drift punch and rotate hook to unscrew it from nut. Separate hook, shroud and thrust washer from body. Note that bearing surface of washer faces nut.
- (4) To remove chain sprocket from upper suspension hanger, first remove hanger as outlined in Paragraph 7-2.a.(4). With hanger removed, push sprocket pin from hanger and sprocket. Note: Sprocket pin must

be removed toward side having small anti-rotation pin slot in hanger.

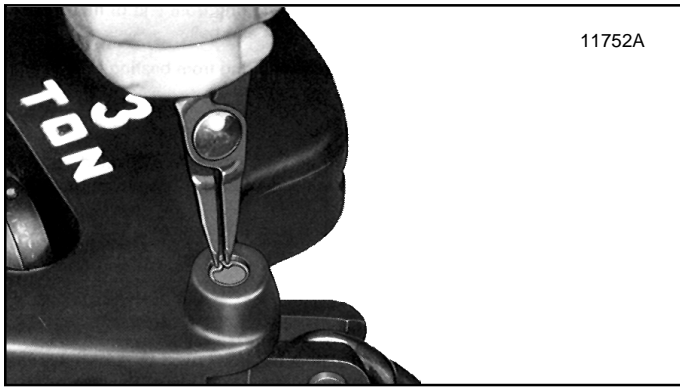

Figure 7-27. Removing Retaining Ring From Bore of Connecting Link Pin - Triple Reeved Lower Block Assembly

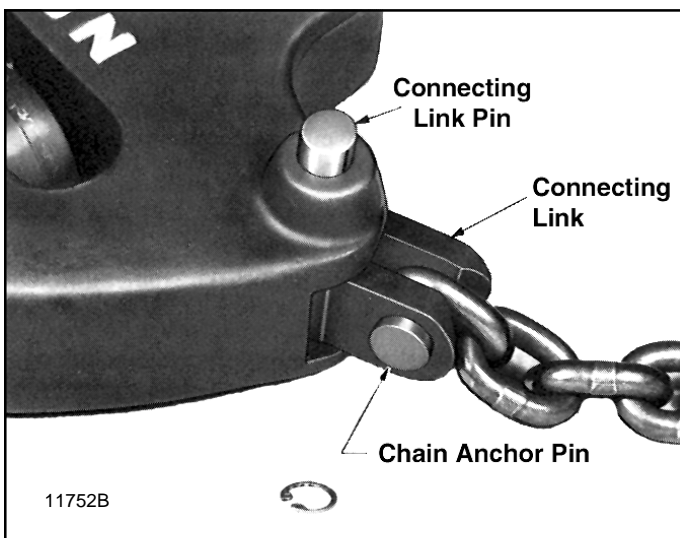

Figure 7-28. Removing Connecting Link Pin From Triple Reeved Lower Block Assembly

d. Reassembly of Lower Blocks.

- (1) Clean, inspect and replace worn or damaged parts.
- (2) Lubricate and reassemble following a reverse procedure of the disassembly steps above.

7-6. REBUILD OF PENDANT THROTTLE CONTROL ASSEMBLY

a. Disassembly.

- (1) Disconnect three air hoses from top of throttle control assembly.
- (2) Remove hex head cap screw and washer holding wire rope thimble and strain cable to supply head assembly.
- (3) Remove two large hex head threaded caps from throttle control assembly side opposite control levers.
- (4) Remove spring from under each cap.
- (5) Remove each spool valve by threading a #10-24 screw into tapped hole in valve and pulling valve out.

b. Reassembly.

- (1) Before assembly, all parts should be thoroughly cleaned and inspected to determine their serviceability. Replace all parts that are worn or damaged.
- (2) Reassemble parts in reverse of the disassembly steps above.

7-7. REBUILD OF SUPPLY HEAD ASSEMBLY

a. Disassembly. (See Figure 8-6.)

- (1) Disconnect three air hoses leading to the pendant throttle control assembly.
- (2) Remove hex head cap screw and washer holding wire rope thimble and strain cable for pendant throttle control assembly.
- (3) Remove two long hex head cap screws, with lockwashers, running from supply head to muffler assembly and remove muffler assembly.
 - (a) Remove two pan head screws and remove muffler cover.
 - (b) Remove muffling material and screen.
- (4) Remove two hex socket cap screws and lockwashers on side of supply head assembly and remove supply head assembly from air motor body.
- (5) To gain access to the valves, remove the retaining rings and screens at the ports and pull out the muffling material.
- (6) Remove the two pan head screws on the side of the supply head assembly to release the valves inside the assembly.
- (7) Pull valve sleeve, spring, and stem out of the supply head assembly. Valve parts may be reached by using needle nose pliers.

Early hoist models utilized a plastic valve and valve base. When rebuilding supply head, replace these with the new valve sleeve, spring, and stem.

b. Reassembly. (See Figure 8-6)

- (1) Before assembly, all parts should be thoroughly cleaned and inspected to determine their serviceability. Replace all parts that are worn or damaged.
- (2) Install muffler screen diagonally in cavity with square end resting against back above circular contour and notched end straddling bottom rib near opening.
- (3) Install muffling material above screen and mount gasketed cover with screws.
- (4) Install valve springs and stems in sleeves and lubricate.
- (5) Slide sleeves into position in supply head (small, single hole on side of sleeves must align with retaining screws) and reinstall retaining screws.
- (6) Replace supply head gasket. Position gasket so that no portion of ports is covered.

7-8. REBUILD OF AIR MOTOR.

- a. General. For removal of supply head assembly and muffler assembly, see Paragraph 7-7.
- b. Disassembly.
 - (1) Remove four hex socket cap screws and then remove motor from hoist.
 - (2) Remove three fillister head screws, end cap and gasket.
 - (3) Remove six hex head bolts holding rear end plate to motor cylinder.
 - (4) Hold the shaft in a soft jawed vise and using a puller, adapted to fit the three #10-32 bolt centers of the end cap, remove rear end plate and shim gasket. Do not try to pry the end plate from the motor.
 - (5) Remove six hex socket cap screws from front end plate.
 - (6) Remove motor body exposing the rotor assembly while leaving front end plate mounted on shaft. This relationship should be maintained to eliminate the necessity of adjusting the motor upon reassembly.
 - (7) Remove vanes, springs, and pins.

Note: Motors requiring further disassembly should be sent to an authorized YALE repair station for repairs.

c. Reassembly.

- (1) Before assembly, all parts should be thoroughly leaned and inspected to determine their serviceability. Replace all worn or damaged parts.
- (2) Position assembly vertically with rotor facing upward. Insert push pins in rotor. Place shim gasket and motor body on end plate, using dowel pins for positioning. Insert vanes and springs into rotor. Take care that spring tab is positioned in slot of vane.
- (3) Install six hex socket head screws through front end plate.
- (4) Place shim gasket and rear end plate on body, using dowel pints for positioning. Press rear bearing onto rotor shaft by pressing on inner race. Bearing outer race should not be bottomed on rear end plate.
- (5) Install six hex head bolts through rear end plate.
- (6) Replace end cap and gasket and install three fillister screws.
- (7) Position motor in proper orientation on hoist and fasten with four hex socket head screws.

7-9. REASSEMBLY OF HOIST FROM SUBASSEMBLIES.

- a. General. The procedure to be followed to reassemble the hoist from subassemblies is in reverse order of the disassembly steps outlined in Paragraph 7-2. Listed below are special precautions which should be observed to assure proper assembly.
- b. Assembly of Load Brake Thrust Washers. When reinstalling load brake assembly be certain thrust washers are properly installed at both ends of load brake shaft, as

noted below.

- (1) A bronze thrust washer with a lug on one side belongs on pinion end of shaft and must be installed so that its lug engages the special slot located on spotface surrounding bearing bore inside gearcase cover. Use heavy grease to hold washer in proper position in cover during assembly.
- (2) A 5/8" I.D. steel thrust washer is to be installed on the brake flange end (end opposite pinion) of load brake assembly.

c. Assembly of Load Chain.

Note: Coil chain must be installed so welds on vertical links face away from the load sprocket.

- (1) Install load chain over sprocket before load brake assembly is installed. Insert anchor end of chain (end opposite lower block on single reeved models) into chain guide opening on far side of hoist (viewing frame from anchor screw side). Rotate sprocket gear by hand counterclockwise as chain is fed into opening. When sufficient chain has been run into hoist to reach anchor position, plus a slack loop, install limit actuator on anchor end of load chain (see (2) below) and attach end of chain to frame with special fillister head screw. Be certain chain is not twisted.
- (2) When installing limit actuator on anchor end of load chain attach it according to chart in Section 3-2.
- (3) When installing limit actuator at lower block, single line models only, actuator slides freely on chain. Place urethane bumper above the limit actuator.

d. Lubricate Hoist. Lubricate hoist as outlined in Section IV.

7-10. TESTING HOIST.

- a. General. After completion of reassembly and before placing hoist in service, hoist should be tested to insure safe operation. To test: suspend hoist from an overhead supporting member of sufficient strength to carry rated load; connect to an air supply of the specified capacity and perform the following checks and adjustments.
- b. Check that load hook will travel in the correct direction when up and down levers are depressed. Make correction, if necessary, by interchanging the two supply hoses at the pendant station. Upper ends of each supply hose are made to "nest" one above the other. Down supply hose has a speed adjustment screw as part of the elbow fitting.
- c. Check Upper and Lower Limit Stop Operation. To determine if upper and lower limit stop functions properly, make the following checks.
 - (1) Depress "UP" lever and inch limit actuator (on single reeved models) or lower block up into limit stop to see that clutch will slip.
 - (2) Depress "DOWN" lever and inch limit actuator up into limit stop to see that clutch will slip.
- d. Check Hoist With Capacity Load. Attach rated capacity load (or load to be handled) to lower hook and check hoist operation. If hoist does not lift rated load, refer to Paragraph 7-11.

⚠ WARNING

DO NOT LIFT MORE THAN RATED LOAD EXCEPT FOR TEST PURPOSES

SECTION VIII - REPLACEMENT PARTS.

This section contains complete replacement parts information for your new **YALE** KALC Air Hoist. The parts are grouped and illustrated to permit easy identification. Each part in an illustration is keyed by reference number to a corresponding parts table. In the table will be found the BH or BAH part number, description and quantity required.

When ordering replacement parts it will be necessary that you include, with your order, the BH or BAH part number of parts required, plus, hoist catalog number and model number, which will be found on the hoist nameplate attached to hoist.

Complete inspection, maintenance and overhaul service is available for **YALE** KALC Air Hoists at any **YALE** Authorized Repair Station. All are staffed by qualified factory-trained service men; have authorized testing equipment; and stock a complete inventory of genuine **YALE** replacement parts.

Notice: Information herein is subject to change without notice. Parts must be ordered from an Authorized **YALE** Repair Station or from a **YALE** Hoist Distributor.

⚠ WARNING

NON-FACTORY AUTHORIZATIONS OR MODIFICATION OF EQUIPMENT AND USE OF NONFACTORY REPAIR PARTS CAN LEAD TO DANGEROUS OPERATION AND INJURY

TO AVOID INJURY:

- Do not alter or modify equipment without factory authorization.
- Do use only factory provided replacement parts.

The numbers assigned to the parts of the various assemblies in the parts list are not the part numbers used in manufacturing the part. They are identification numbers, that when given with the catalog number, permits us to identify, select or manufacture, and ship the correct part needed.

INDEX OF EXPLODED VIEW PARTS ILLUSTRATIONS

Figure No.	Title	Page
8-1	Frame and External Parts	25
8-2	Upper Suspension, Load Chain and Lower Block Parts (2 Ton Capacity Hoists)	27
8-3	Upper Suspension, Load Chain and Lower Block Parts (3 Ton Capacity Hoists)	29
8-4	Gearing and Load Brake Parts	31
8-5	2 and 3 Ton Lower Block Assembly	33
8-6	Supply Head and Muffler Parts	34
8-7	Air Motor Parts	35
8-8	Pendant Throttle Control Parts	36
8-9	Special Parts Table - Corrosion Resistant and Spark Resistant Models	37

To enable us to expedite your parts order, always give Model and Catalog Number of Hoist. (See nameplate.)

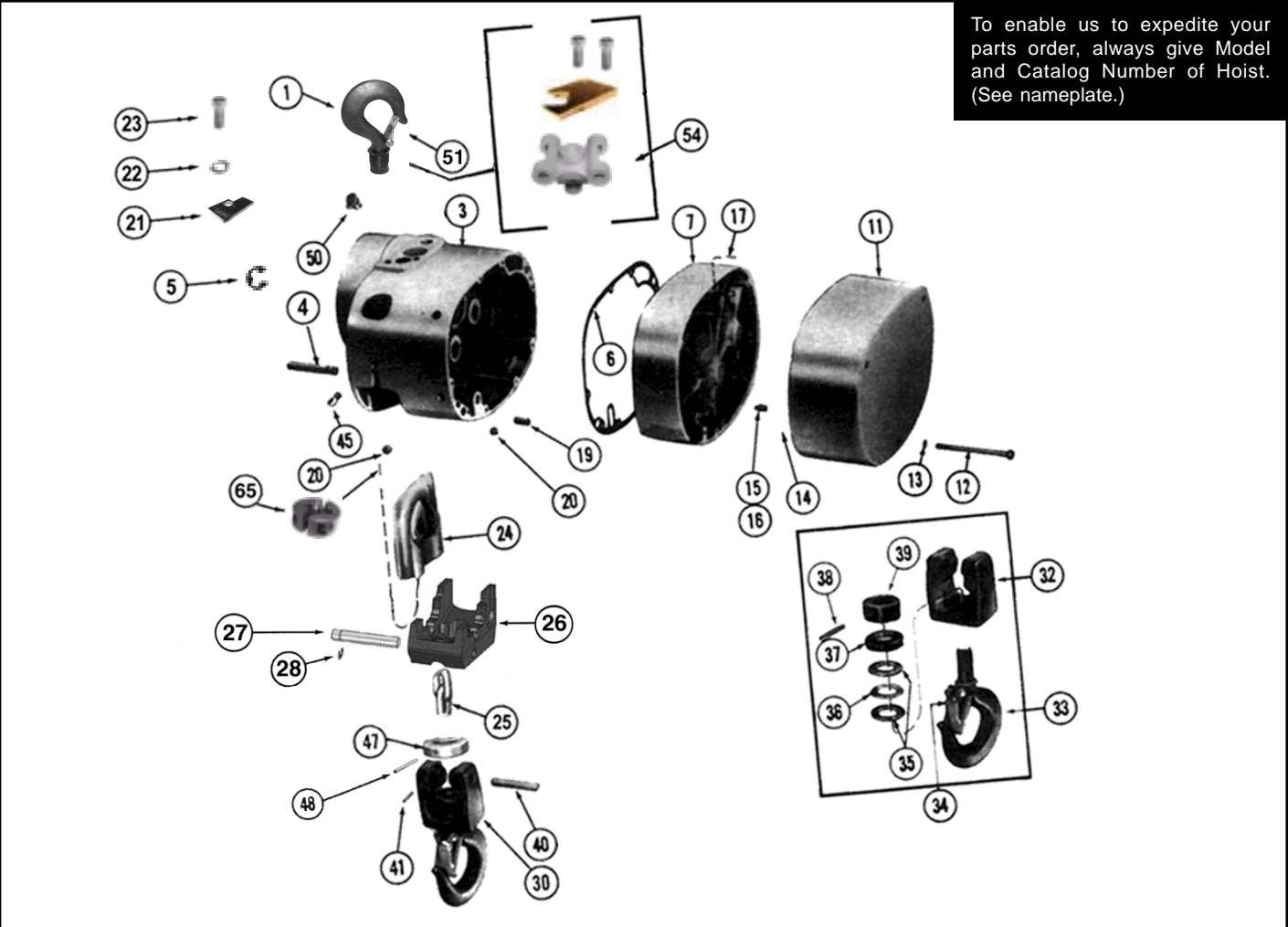

Figure 8-1. FRAME AND EXTERNAL PARTS
Standard Hoists
 (Except 2 & 3 Ton Model Upper Suspension, Load Chain and Lower Block)

Ref. No.	Part Number	Description	Qty. Req'd
1	BH-4007A	Hook Assembly - Upper with latch (Includes Item 51)	1*
	BH-5033	Hook Assembly - Upper with latch (Includes Item 51) Plated	1
3	BH-4004	Frame Assembly (Includes 2 bushings, 2 needle bearings, 1 oil seal, 1 oil filler, 2 pipe plugs, and 2 dowel pins)	1
4	BH-5009	Pin - Support, chain guide	2
5	BH-4008	Retaining Clip	4
6	BH-1007	Gasket - Gearcase	1
7	BH-1009	Cover Assembly - Gearcase (Includes 2 needle bearings and 2 grooved pins).	1
11		Cover - Counterweighted	
	BH-1190	(1 ton)	1
	BH-1191	(2 ton)	1
	BH-1192	(3 ton)	1
12	BH-1020	Screw - Fillister Head Machine	3
13	BH-1021	Lockwasher - Spring Type	3
14	BH-1022	Ring - Retaining	3
15	BH-1023	Lockwasher - Spring Type	8
16	BH-1024	Screw - Hex Socket head	8
17	BH-1025	Pin - Grooved	2
18	BH-1026	Grommet - Not Shown	1
19	BH-1027	Pin - Dowel, gearcase cover	2
20	BH-1028	Plug - Pipe, hex Socket, 1/8"	2

(Continued on following page)

Figure 8-1. FRAME AND EXTERNAL PARTS - Continued

Ref. No.	Part Number	Description	Qty. Req'd
21	BH-5023	Suspension Bushing Keeper	1*
22	BH-4016	Lock Washer	1*
23	BH-4017	Hex socket Cap Screw	1*
24	BH-1032	Guide Assembly - Coil Load Chain	1
25	BH-1034***	Chain Assembly - Coil, Load	1*
	BH-1086	Chain Assembly - Coil, Load Plated	1
26	BH-5020	Stop Shoe	1
27	BH-5021	Support Pin	1
28	BH-5022	Retaining Ring	1
30	BH-5046	Block Assembly - Lower (Includes items 32 through 39)	1*
	BH-5030	Block Assembly - Lower (Includes items 32 through 39) Plated	1
32	BH-1175	Body - Lower Block	1*
	BH-5033	Body - Lower Block Plated	1
33	BH-5047	Hook, Nut and Latch Assembly - Lower Block	1*
	BH-5034	Hook, Nut and Latch Assembly - Lower Block Plated	1
34	BH-5035	Latch Kit - Hook, lower	1*
35	BH-1178	Washer - Thrust, Needle bearing	2*
36	BH-1179	Bearing Assembly - Needle, thrust	1*
37	BH-1180	Shield - Bearing	1*
38	BH-1181	Pin - Spring drive	1*
39	**	Nut - Hook	1*
40	BH-1038	Pin - Connecting, lower block	1*
41	BH-1045	Pin - Spring drive	1*
45	BH-1052	Screw - Fillister Head, Self Locking	1
50	BH-1058	Filler Assembly - Oil	1
51	BH-1183	Latch Kit- Hook (upper)	1*
54	BH-5025	Lug Suspension Assembly	1*
64	BH-1063	Urethane Bumper	1
65	BH-5010	Chain Stop Assembly	1
66	BH-5012	Stop Plate	1
67	BH-5013	Button Head Cap Screw	4
68	BH-1410	Lockwasher	

* Refer to Figure 8-2 for 2 Ton Model Upper Suspension, Load Chain and Lower Block Parts. Refer to Figure 8-3 for 3 Ton Model Upper Suspension, Load Chain and Lower Block parts.

*** Load Chain Assemblies listed are for hoists with standard 10 ft. lifts. Bulk chain is available in 1 ft., increments, part number BH-1069.

To enable us to expedite your parts order, always give Model and Catalog Number and Electric Current of Hoist. (See nameplate.)

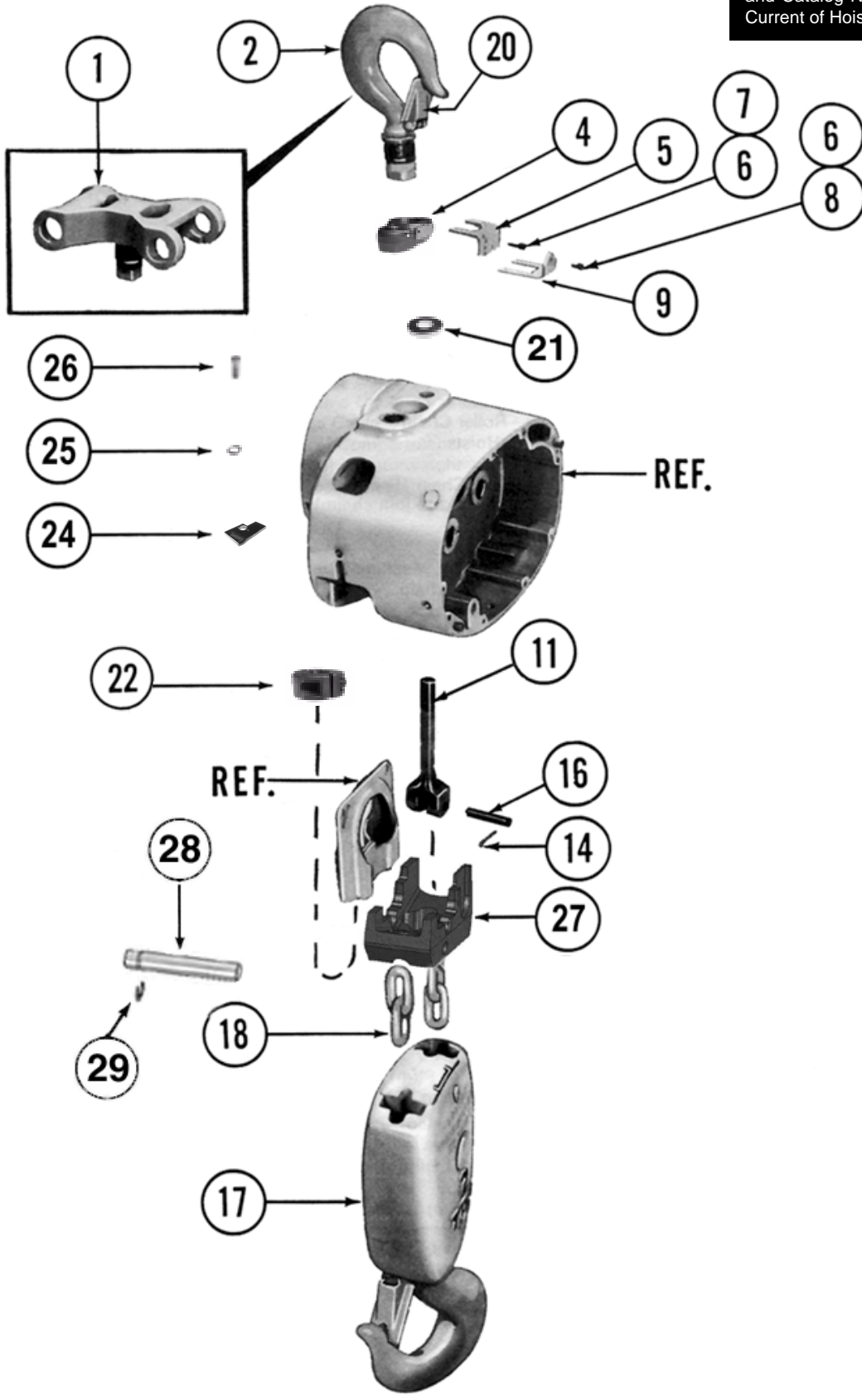

10251D

Figure 8-2. UPPER SUSPENSION, LOAD CHAIN AND LOWER BLOCK PARTS
(2 ton Capacity Hoists)

Figure 8-2. UPPER SUSPENSION, LOAD CHAIN AND LOWER BLOCK PARTS - Continued

Ref. No.	Part Number	Description	Qty. Req'd
1	905422	Bracket Assembly Kit- Lug Suspension (Coil Chain Model Only. Includes Items 6, 8 and 9)	1
2	BH-1102	Hook Assembly-Upper (Includes Items 5, 6, 7 and 20)	1
	BH-5036	Hook Assembly-Upper (Includes Items 5, 6, 7 and 20) Plated	1
4		Block Assembly-Upper	1
	BH-4013	Coil Chain Models, Includes Items 3, 11, 14, 16 and 21	
5	BH-1106	Lock Assembly-Suspension Bushing	1
6	BH-1107	Regular Helical Spring Lock Washer (#10 Pltd.)	3
7	BH-1108	Hex, Socket Head Cap Screw (#10-24 x 1/2)	2
8	BH-1109	Hex, Socket Head Cap Screw (#10-24 x 3/8)	1
9	BH-1061	Plate - Lock (Coil Chain Lug Suspension Models Only)	1
11	*	Anchor - Coil Load Chain	1
14	BH-1111	Cotter Pin (3/32 x 3/4)	1
16	BH-1113	Pin-Coil Chain Anchor	1
17	(See Fig. 8-5)	Block Assembly-Lower (Coil Chain Models)	1
18**	BH-1114	Chain Assembly-Coil Load	1
	BH-1115	Chain Assembly-Coil Load (Zinc Plated)	1
20	BH-2213	Latch Kit-Hook	1
21	BH-4012	Spacer Washer	1
22	BH-5010	Chain Stop	1
24	BH-5023	Suspension Bushing Keeper	1
25	BH-4016	Lock Washer	1
26	BH-4017	Hex Socket Head Cap Screw	1
27	BH-5020	Stop Shoe	1
28	BH-5021	Support Pin	1
29	BH-5022	Retaining Ring	1

* Not available as individual parts. Order upper block assembly, Item 4.

** Load Chain Assemblies listed are for hoists with standard 10 ft. lists. Bulk chain is available in 1 ft. increments and part number BH-1069.

To enable us to expedite your parts order, always give Model and Catalog Number and Electric Current of Hoist. (See nameplate.)

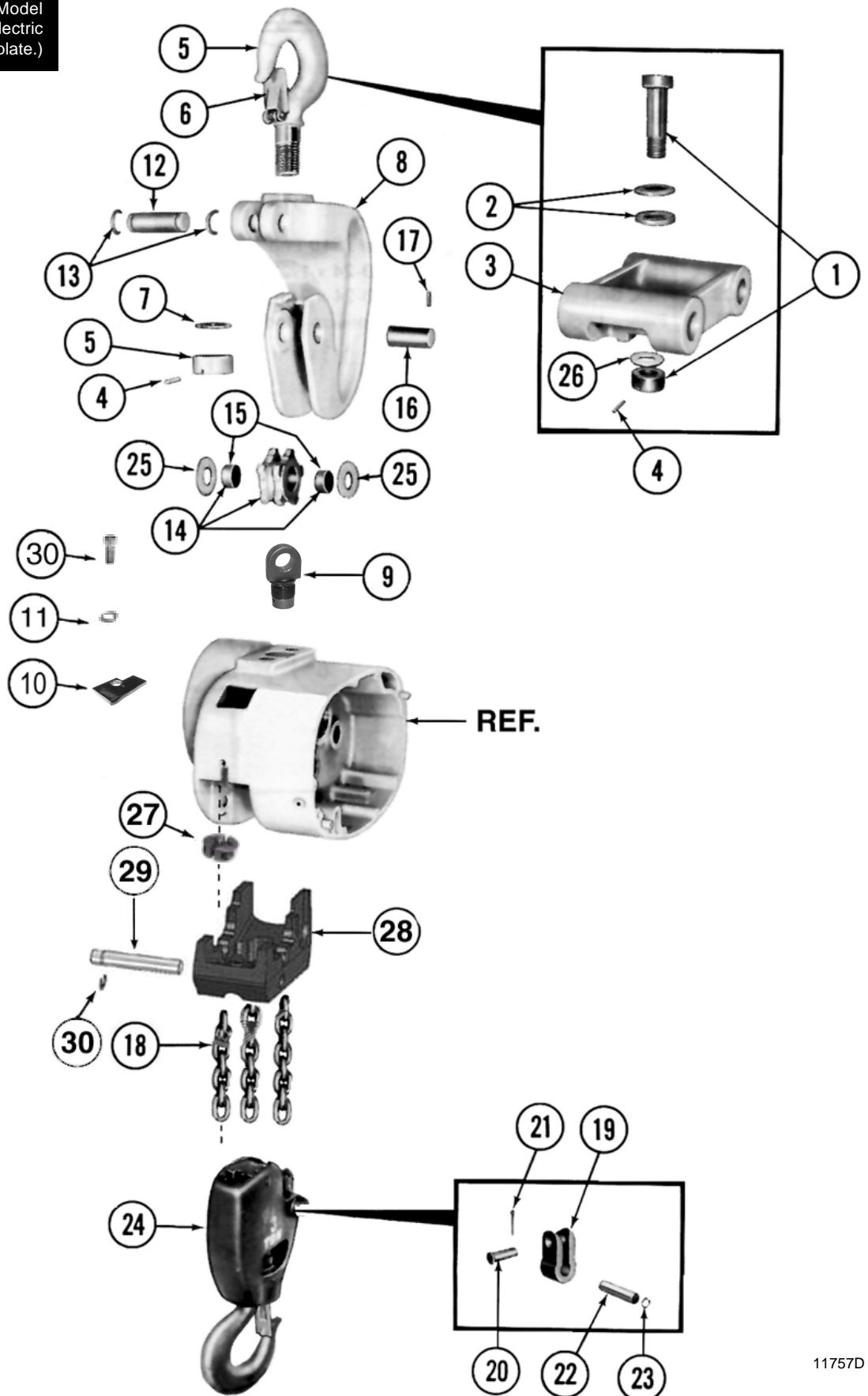

Figure 8-3. UPPER SUSPENSION, LOAD CHAIN AND LOWER BLOCK PARTS
(3 ton Capacity Hoists)

Figure 8-3. UPPER SUSPENSION, LOAD CHAIN AND LOWER BLOCK PARTS - Continued

Ref. No.	Part Number	Description	Qty. Req'd
1	BH-1131	Suspension Pin and Nut Assembly	1
2	BH-1132	Spherical Washer	1 Pr.
3	905424	Suspension Lug Kit (Includes Items 1, 2, 4 and 26)	1
4	BH-1134	Pin - Grooved (Type A 3/16 x 2 Pltd.)	1
5	BH-1135	Hook/Latch and Nut (Includes Item 6)	1
	BH-5037	Hook/Latch and Nut (Includes Item 6) Plated	1
6	BH-2214	Latch Kit, Hook	1
7	BH-2217	Washer, Thrust	1
8	BH-1138	Hanger	1
9	BH-4018	Connecting Rod Assembly	1
10	BH-5023	Suspension Bushing Keeper	1
11	BH-4016	Lock Washer	1
12	BH-1142	Pin, Connection	1
13	BH-1143	Ring, Retaining	2
14	BH-1144	Sprocket & Bushing Assembly (Includes Item 15)	1
15	BH-1145	Bushing	2
16	BH-5019	Pin, Sprocket	1
17	BH-1147	Grooved Pin (Type A 3/16 x 3/8 Pltd.)	1
18	BH-1148	Chain Assembly, Coil Load	1
	BH-5045	Chain Assembly, Coil Load Plated	1
19	BH-1149	Link, Connecting	1
20	BH-1150	Pin, Anchor	1
21	BH-1151	Cotter Pin (3/32 x 3/4)	1
22	BH-1152	Dowel Pin (1/2 x 2-1/4)	1
23	BH-1153	Ring, Retaining	1
24	See Fig. 9-4	Block Assembly, Lower, Coil Chain	
25	BH-2210	Washer, Thrust	2
26	BH-1154	Washer	1
27	BH-5010	Chain Stop Assembly	1
28	BH-5020	Stop Shoe	1
29	BH-5021	Support Pin	1
30	BH-5022	Snap Ring	1

NOTICE

Always insist on factory approved **Yale** Hoist replacement parts when servicing this equipment. Parts are available from your local Authorized Repair Station.

NOTES

To enable us to expedite your parts order, always give Model and Catalog Number of Hoist. (See nameplate.)

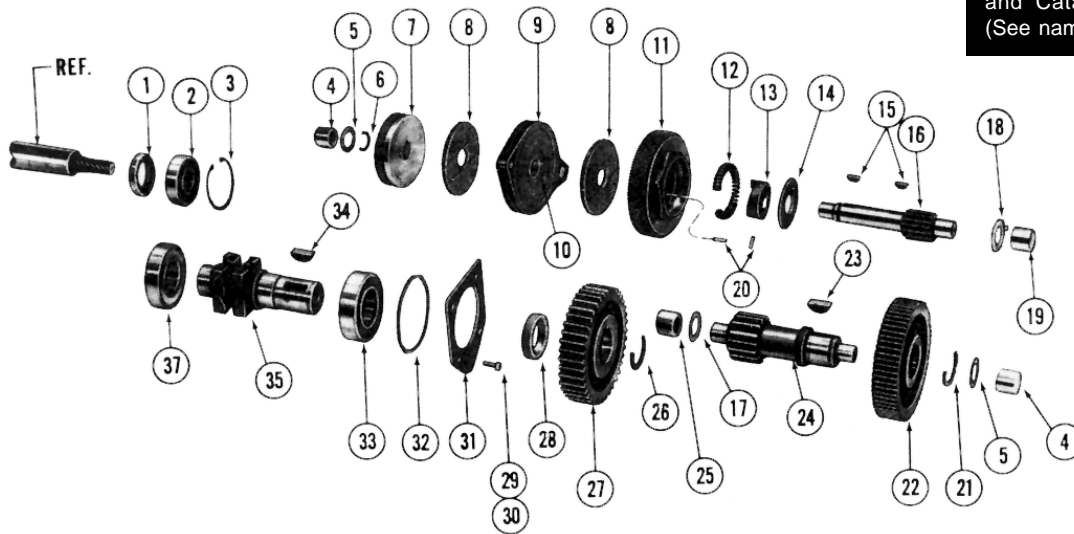

11899A

Figure 8-4. GEARING AND LOAD BRAKE PARTS

Ref. No.	Part Number	Description	Qty. Req'd
2	BH-1202	Bearing Assembly - Ball, Motor Shaft	1
3	BH-1203	Ring - Retaining, Internal	1
4	BH-1220	Bearing Assembly - Needle, 5/8" I.D.	2
5	BH-1221	Washer - Thrust 5/8" I. D.	2
6	BH-1222	Ring - Snap, Brake Flange	1
7	BH-1219	Flange - Load Brake	1
8	BH-1218	Disc - Friction, Load Brake	2
9	BH-1223	Pawl & Ratchet Assembly - Load Brake (Includes item 10)	1
10	BH-1238	Bushing - Ratchet	1
11		Gear & Clutch Assembly - Load Brake	1
	BH-1242*	Standard Speed Hoist	
	BAH-1245*	Reduced Speed Hoist	
12	BH-1212	Spring - Load Brake (Plain - no color code)	1
13	BH-1216	Cam - Load Brake	1
14	BH-1239	Retainer - Spring, Load Brake	1
15	BH-1210	Key - Woodruff	2
16		Shaft & Integral Pinion - Load Brake	1
	BH-1207	14 Teeth	
	BH-1208	23 Teeth	
17	BH-1206	Washer-Thrust, 11/16" I.D.	1
18	BH-1205	Bearing -Thrust, Bronze	1
19	BH-1204	Bearing Assembly - Needle, 11/16" I.D.	1
20	BH-1214	Pin - Grooved	2
21	BH-1224	Ring - Snap, Intermediate Gear	1
22		Gear - Intermediate	1
	BH-1225	74 Teeth	
	BH-1226	65 Teeth	
23	BH-1236	Key - Woodruff	1
24	BH-1304	Shaft & Integral Pinion - Intermediate	1
25	BH-1237	Bearing Assembly - Needle, 11/16" I.D. (36 roller, greased retained)	1
26	BH-1305	Ring - Snap, Sprocket Gear	1
27	BH-1306	Gear - Sprocket	1
28**	BH-1307	Spacer - Sprocket Gear	1

(Continued on following page)

To enable us to expedite your parts order, always give Model and Catalog Number of Hoist. (See nameplate.)

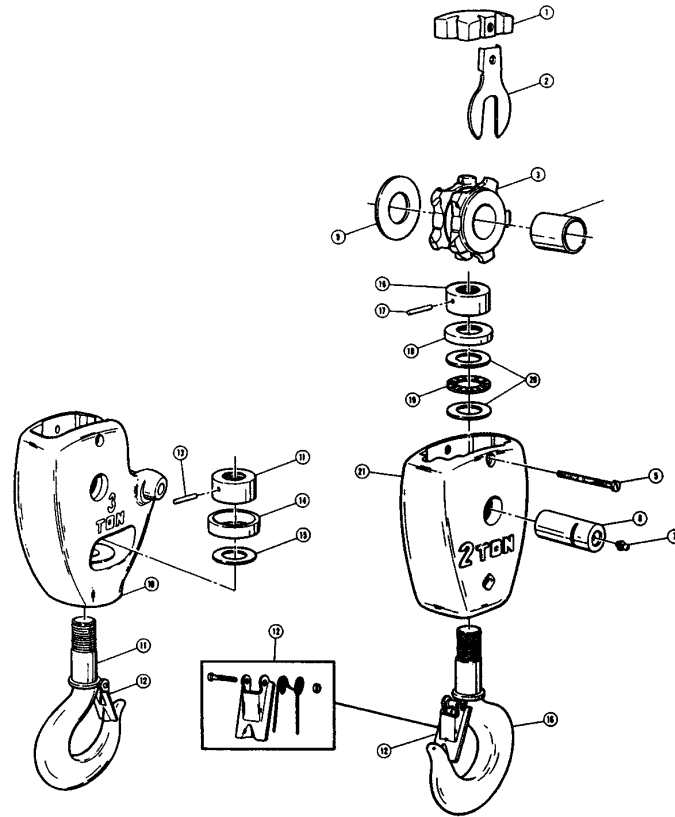

12439

Figure 8-5. 2 & 3 TON LOWER BLOCK ASSEMBLIES

Ref. No.	Part Number	Description	Quantity Required	
			2 Ton	3 Ton
	BH-2219	Block Assembly - Lower Complete	1	-
	BH-5038	Block Assembly - Lower Complete Plated	1	-
	BH-2218	Block Assembly - Lower Complete	-	1
	BH-5039	Block Assembly - Lower Complete Plated	-	1
1	BH-2202	Guide - Center	1	1
	BH-5042	Guide - Center Anodized	1	1
2	BH-2203	Lock - Sprocket Pin	1	1
3	BH-2204	Sprocket - Coil Chain	1	1
4	BH-2205	Bushing - Sprocket	1	1
5	BH-2206	Screw - Fillister Head, Self locking	1	1
6	BH-2207	Pin - Sprocket	1	1
7	BH-2208	Fitting - Hydraulic Drive	1	1
9	BH-2210	Washer, Thrust	1	1
10	BH-2211	Body Assembly - Lower Block	-	1
	BH-5040	Body Assembly - Lower Block Anodized	-	1
11	BH-2212	Hook/Latch & Nut (Includes Items 12, 13 & 15)	-	1
	BH-5044	Hook/Latch & Nut (Includes Items 12, 13 & 15) Plated	-	1
12	BH-2213	Latch Kit, Hook	1	-
	BH-2214	Latch Kit, Hook	-	1
13	BH-2215	Pin, Grooved	-	1
14	BH-2216	Shroud	-	1
15	BH-2217	Washer, Thrust	-	1
16	BH-2220	Hook/Latch & Nut (Includes Items 12 & 17)	1	-
	BH-5043	Hook/Latch & Nut (Includes Items 12 & 17) Plated	1	-
17	BH-2221	Pin, Grooved	1	-
18	BH-2222	Shield, Bearing	1	-
19	BH-2223	Bearing Assembly - Needle, Thrust	1	-
20	BH-2224	Washer, Thrust	2	-
21	BH-2225	Body - Lower Block	1	-
	BH-5041	Body - Lower Block Anodized	1	-

To enable us to expedite your parts order, always give Model and Catalog Number of Hoist. (See nameplate.)

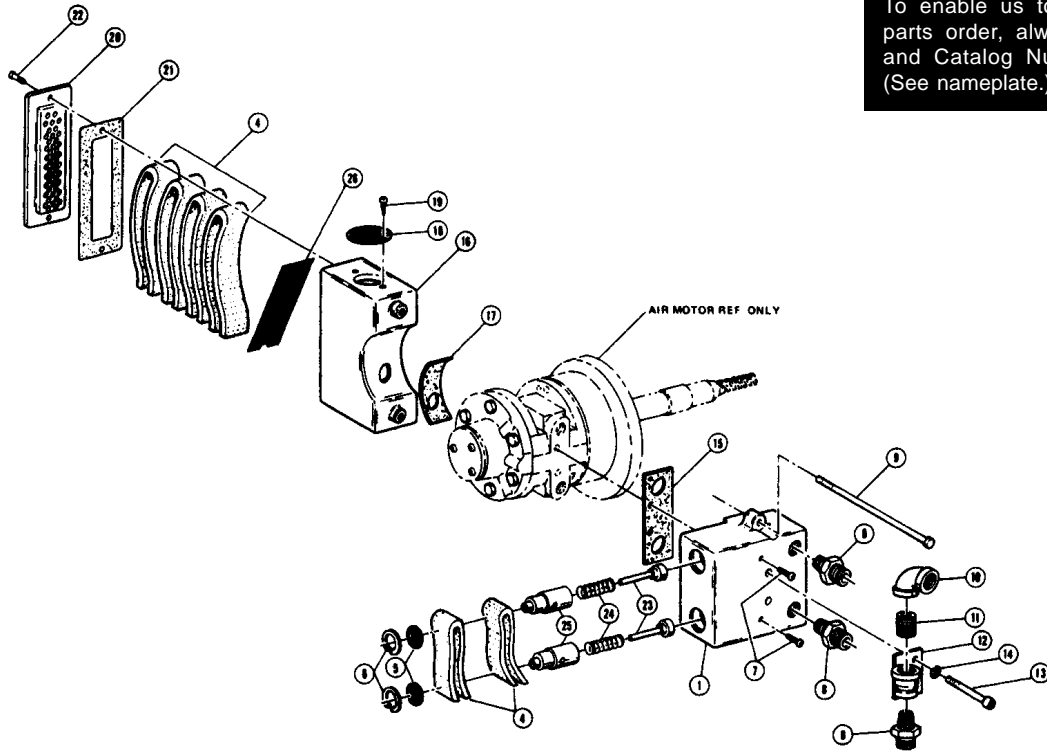

12441A

Figure 8-6. SUPPLY HEAD AND MUFFLER PARTS

Ref. No.	Part Number	Description	Qty. Req'd
1	BAH-5100	Supply Head	1
2*	BAH-5101	Valve Support	2
3*	BAH-5102	Valve Guide Assembly	2
4	BAH-5103	Muffling Material	6
5	BAH-5104	Screen - Exhaust Valve	2
6	BAH-5105	Ring - Internal Retaining	2
7	BAH-5106	Screw - Self Tapping	2
8	BAH-5107	Adaptor Fitting	3
9	BAH-5108	Cap Screw - Hex Head	2
10	BAH-5109	Elbow - Reducing	1
11	BAH-5110	Nipple - Close Pipe	1
12	BAH-5111	Coupling Assembly	1
13	BAH-5112	Cap Screw - Hex Socket	2
14	BAH-5113	Lockwasher - Spring Type	2
15	BAH-5114	Gasket - Supply Head	1
16	BAH-5115	Muffler Body	1
17	BAH-5117	Gasket - Muffler	1
18	BAH-5117	Screen - Muffler	1
19	BAH-5118	Screw - Drive	2
20	BAH-5119	Muffler Cover	1
21	BAH-5120	Gasket - Muffler Cover	1
22	BAH-5121	Screw - Pan head	2
23*	BAH-5123	Stem - Valve	2
24*	BAH-5124	Spring - Valve	2
25*	BAH-5125	Sleeve - Valve	2
26	BAH-5126	Screen - Muffler	1

* Reference Numbers 23, 24, and 25 replace Reference Numbers 2 and 3 used on earlier model hoists.

To enable us to expedite your parts order, always give Model and Catalog Number of Hoist. (See nameplate.)

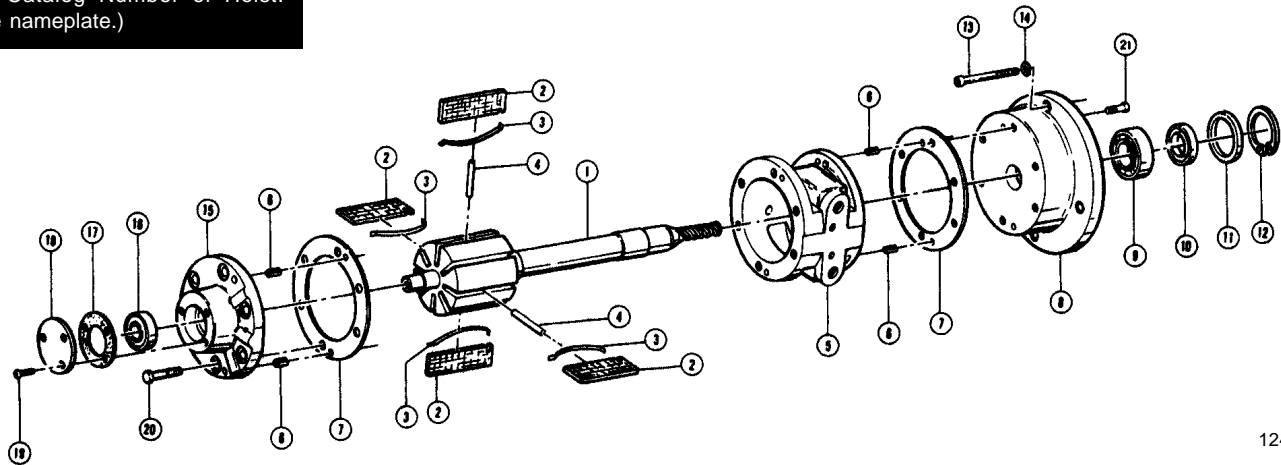

12442A

Figure 8-7. AIR MOTOR PARTS

Ref. No.	Part Number	Description	Qty. Req'd
	BAH-5200	Air Motor Assembly	1
1	BAH-5201	Rotor and Shaft Assembly	1
2	BAH-5202	Vane	8
3	BAH-5203	Spring - Vane	8
4	BAH-5204	Push Pin	4
5	BAH-5205	Body -Air Motor	1
6	BAH-5206	Pin - Dowel	4
7	BAH-5207	Gasket - Body	2
8	BAH-5208	End Plate - Drive End	1
9	BAH-5209	Bearing - Drive End	1
10	BAH-5210	Shaft Seal	1
11	BAH-5211	Seal Adaptor	1
12	BAH-5212	Ring - Retaining	1
13	BAH-5213	Cap Screw - Hex Socket	4
14	BAH-5214	Lockwasher - Spring Type	4
15	BAH-5215	End Plate - Dead End	1
16	BAH-5216	Bearing - Dead End	1
17	BAH-5217	Gasket - End Cap	1
18	BAH-5218	End Cap - Dead End	1
	BAH-5219	End Plate Puller Tool (Not Shown)	-
19	BAH-5220	Screw	3
20	BAH-5221	Screw	6
21	BAH-5222	Screw	6

To enable us to expedite your parts order, always give Model and Catalog Number of Hoist. (See nameplate.)

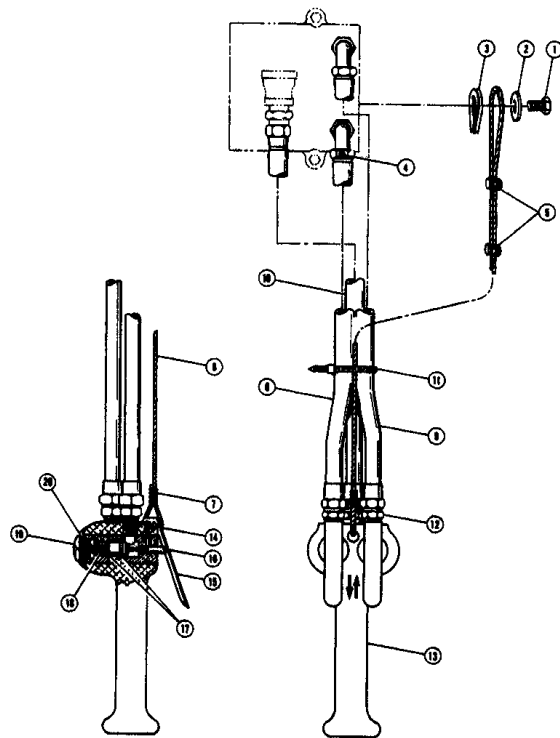

12443

Figure 8-8. PENDANT THROTTLE CONTROL PARTS

Ref. No.	Part Number	Description	Qty. Req'd
1	BAH-5300	Cap Screw - Hex Head	1
2	BAH-5301	Washer	1
3	BAH-5302	Thimble - Wire Rope	1
4	BAH-5303	Set Screw	1
5	BAH-5304	Clip - Wire rope	2
6	BAH-5305	Cable - Strain Relief (Specify length Required) 7 ft. for 10 ft. Lift 12 ft. for 15 ft. Lift 17 ft. for 20 ft. Lift	1 1 1
7	BAH-5306	Sleeve - Pressed	1
8		Hose Assembly - Down BAH-5307 For 10 ft. Lift BAH-5308 For 15 ft. Lift BAH-5309 For 20 ft. Lift	1 1 1
9		Hose Assembly - UP BAH-5310 For 10 ft. Lift BAH-5311 For 15 ft. Lift BAH-5312 For 20 ft. Lift	1 1 1
10		Hose Assembly - Supply BAH-5313 For 10 ft. Lift BAH-5314 For 15 ft. Lift BAH-5315 For 20 ft. Lift	1 1 1
11	BAH-5316	Tie - Cable	2
12	BAH-5317	Adaptor Fitting	3
13	BAH-5318	Pendant Throttle Handle Assembly - Complete (Includes Ref. Nos. 14 through 20 plus handle)	1
14	BAH-5319	Pin - Throttle Lever	1
15	BAH-5320	Throttle Lever	2
16	BAH-5321	Valve - Throttle	2
17	BAH-5322	Ring - Throttle Valve Seal	4

Figure 8-9. SPECIAL PARTS TABLE - CORROSION RESISTANT AND SPARK RESISTANT MODELS

Fig. No.	Ref. No.	Part Number	Description	Corrosion Resistant			Spark Resistant			
				1 Ton	2 Ton	3 Ton	½ Ton	1 Ton	2 Ton	
8-1	1	BAH-5400	Hook Assembly-Upper with Latch	-	-	-	1	-	-	
	11	BAH-5401	Cover - Counterweighted	-	-	-	1	-	-	
		BAH-5402	Cover - Counterweighted	-	-	-	-	1	-	
		BAH-5403	Cover - Counterweighted	-	-	-	-	-	1	
	24	BAH-5430	Guide Assembly - Coil Load Chain	-	-	-	1	1	1	
	25	BAH-5404	Chain Assembly - Coil, Load	1	-	-	-	-	-	
		BAH-5404	Chain Assembly - Coil, Load	-	-	-	1	-	-	
	30	BAH-5406	Block Assembly - Lower	-	-	-	1	-	-	
	32	BAH-5407	Body - Lower Block	-	-	-	1	-	-	
	33	BAH-5408	Hook, Nut and Latch Assembly - Lower Block	-	-	-	1	-	-	
	34	BAH-5409	Latch Kit - Hook, Lower	-	-	-	1	-	-	
	51	BAH-5410	Latch Kit - Hook Upper	-	-	-	1	-	-	
	8-2	2	BAH-5411	Hook Assembly-Upper with Latch	-	-	-	-	1	-
		18	BAH-5412	Chain Assembly - Coil, Load	-	1	-	-	-	-
		BAH-5413	Chain Assembly - Coil, Load	-	-	-	-	1	-	
8-3	20	BAH-5414	Latch Kit - Hook, Upper	-	-	-	-	1	-	
	5	BAH-5415	Hook Assembly - Upper with Latch	-	-	-	-	-	1	
8-4	18	BAH-5417	Chain Assembly - Coil, Load	-	-	1	-	-	-	
		BAH-5418	Chain Assembly - Coil, Load	-	-	-	-	-	1	
	11	BAH-5429*	Gear & Clutch Assembly - Load Brake	-	-	-	1	1	1	
8-5	35	BAH-5419	Sprocket - Coil Chain	-	-	-	1	1	1	
	-	BAH-5420	Block Assembly - Lower Complete	-	-	-	-	1	-	
	-	BAH-5421	Block Assembly - Lower Complete	-	-	-	-	-	1	
	10	BAH-5422	Body Assembly - Lower Block	-	-	-	-	-	1	
	11	BAH-5423	Hook/Latch & Nut	-	-	-	-	-	1	
	12	BAH-5424	Latch Kit - Hook, Lower	-	-	-	-	1	-	
	16	BAH-5426	Hook/Latch & Nut	-	-	-	-	1	-	
21	BAH-5427	Body Assembly - Lower Block	-	-	-	-	1	-		

SAFE IS... BEING SMART!
STUDY MANUFACTURER'S
INSTRUCTION MANUAL. BE
A SKILLED HOIST OPERATOR!

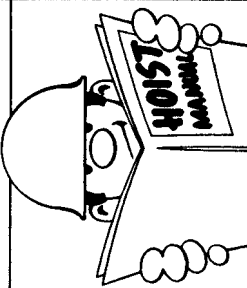

WONG!

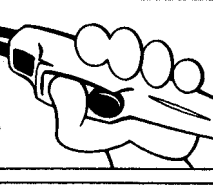

**SAFE IS... A CORRECTLY
CONNECTED HOIST!**

IF A 3-PHASE HOIST
"LOWERS" WHEN "UP"
CONTROL IS ACTUATED-
IMMEDIATELY RECONNECT
ANY TWO POWER LEADS AT
HOIST POWER SOURCE!

FAILURE TO DO SO
WOULD BE **DANGEROUS!**

**SAFE IS... ALWAYS CENTERING
HOIST OVER LOAD
BEFORE LIFTING!**

EXCESSIVE SIDE PULL
CAN DAMAGE HOIST,
TROLLEY, OR ROPE
(CHAIN)... DON'T
SIDE-PULL LOADS!

**SAFE IS... NEVER
TWISTING CHAIN OR
ROPE BY CAPSIZING
LOWER BLOCK!**



**SAFE IS... ALWAYS CHECKING HOIST
BEFORE SHIFT. CHECK
HOOKS, LOAD CHAIN (ROPE),
LIMIT SWITCHES & BRAKES.
- MAKE CERTAIN OF
THEIR CONDITION!**

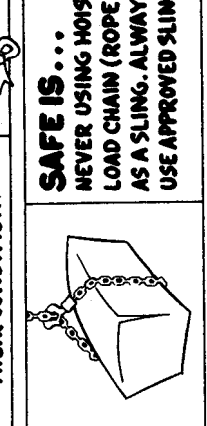

SAFE IS... NEVER OVERLOADING A HOIST!
USE PROPER CAPACITY
HOIST TO FIT THE JOB.
IN DOUBTFUL WEIGHT
SITUATIONS HOISTS WITH
OVERLOAD PROTECTION
DEVICES WILL REJECT
DANGEROUS OVERLOADS
... USE THEM!
**CAUTION: BE SURE
OVERHEAD SUSPENSION
WILL HOLD THE LOAD!**

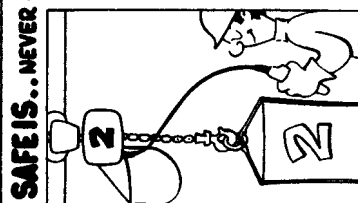

**SAFE IS... NOT OPERATING A HOIST
TO EXTREME LIMITS OF THE
ROPE (CHAIN)!**



LIMIT SWITCHES ARE ONLY FOR
EMERGENCY STOPS!

**SAFE IS... NEVER LEAVING
LOADS SUSPENDED
IN AIR UNATTENDED!**

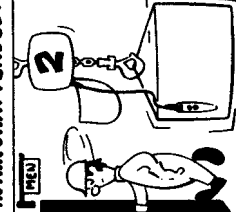

**SAFE IS... USING
A CHAIN CONTAINER
ON ELECTRIC CHAIN
HOIST WHERE NEEDED!**

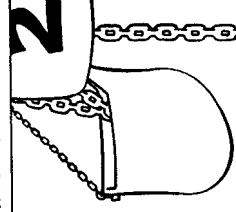

**SAFE IS... NEVER BANGING
HOIST INTO OTHER
HOISTS OR OBJECTS!**

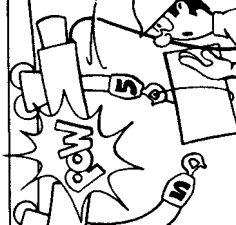

**SAFE IS... NEVER USING A
HOIST TO LIFT OR
LOWER PERSONS!**

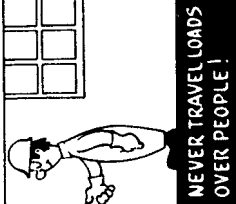

NEVER TRAVEL LOADS
OVER PEOPLE!

**SAFE IS... CAREFULLY TAKING
UP SLACK IN LOAD CHAIN (ROPE).
NEVER APPLY SHOCK LOADS!**

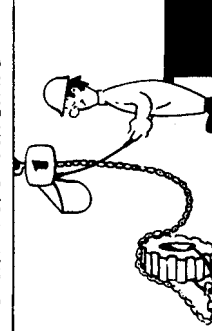

BE A REAL HOISTING PRO!
ALWAYS MAKE SMOOTH LIFTS!

**SAFE IS... NEVER
OPERATING A HOIST
BEYOND ITS DESIGNED
DUTY CYCLE!**

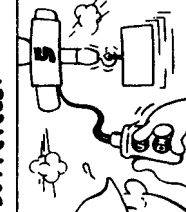

DO NOT JOG HOIST
UNNECESSARILY!

**SAFE IS... MAKING SURE
LOAD IS FREE TO MOVE IN
UNOBSTRUCTED AREA!**

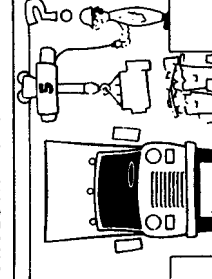

ALWAYS MAKE CERTAIN THE
LANDING AREA IS CLEAR!

**SAFE IS... MAKING SURE
LOAD IS EVENLY BALANCED
AND SECURE IN LOAD SLING!**

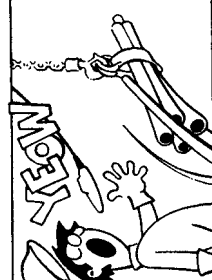

DON'T TAKE
CHANCES!

SAFE IS... ALSO

- USING COMMON SENSE IN TRAVELING LOADS! WATCH WHERE YOU'RE GOING!
- BEING SURE THAT LOAD SLING IS PROPERLY SEATED IN SADDLE OF HOOK WITH LATCH CLOSED!
- BEING A THOUGHTFUL AND COURTEOUS HOIST OPERATOR!

Safe is Beautiful!

Recommended Spare Parts for Your YALE KAL2 Air Hoist

Certain parts of your hoist will, in time, require replacement under normal wear conditions. It is suggested that the following parts be purchased for your hoist as spares for future use.

One Set of Brake Discs
One Set of Gaskets
One Set of Oil Seals and "O" Ring
One Set of Motor Vanes
One Set of Motor Springs
One Set of Motor Pins

Note: When ordering parts always furnish Model Number of Trolley.

Parts for your trolley are available from your local authorized **YALE** repair station. For the location of your nearest repair station, write:

Yale•Lift-Tech

P.O. Box 769
Muskegon, MI 49443-0769

Phone: **800 742-9269**

Fax: **800 742-9270**

WARRANTY

WARRANTY AND LIMITATION OF REMEDY AND LIABILITY

A. Seller warrants that its products and parts, when shipped, and its work (including installation, construction and start-up), when performed, will meet applicable specifications, will be of good quality and will be free from defects in material and workmanship. All claims for defective products or parts under this warranty must be made in writing immediately upon discovery and in any event, within one (1) year from shipment of the applicable item unless Seller specifically assumes installation, construction or start-up responsibility. All claims for defective products or parts when Seller specifically assumes installation, construction or start-up responsibility and all claims for defective work must be made in writing immediately upon discovery and in any event, within one (1) year from completion of the applicable work by Seller, provided; however, all claims for defective products and parts made in writing no later than eighteen (18) months after shipment. Defective items must be held for Seller's inspection and returned to the original f.o.b. point upon request. THE 'FOREGOING IS EXPRESSLY IN LIEU OF ALL OTHER WARRANTIES WHATSOEVER, EXPRESS, IMPLIED AND STATUTORY, INCLUDING, WITHOUT LIMITATION, THE IMPLIED WARRANTIES OF MERCHANTABILITY AND FITNESS.

B. Upon Buyer's submission of a claim as provided above and its substantiation, Seller shall at its option either (i) repair or replace its product, part or work at either the original f.o.b. point of delivery or at Seller's authorized service station nearest Buyer or (ii) refund an equitable portion of the purchase price.

C. This warranty is contingent upon Buyer's proper maintenance and care of Seller's products, and does not extend to normal wear and tear. Seller reserves the right to void warranty in event of Buyer's use of inappropriate materials in the course of repair or maintenance, or if Seller's products have been dismantled prior to submission to Seller for warranty inspection.

D. The foregoing is Seller's only obligation and Buyer's exclusive remedy for breach of warranty and is Buyer's exclusive remedy hereunder by way of breach of contract, tort, strict liability or otherwise. In no event shall Buyer be entitled to or Seller liable for incidental or consequential damages. Any action for breach of this warranty must be commenced within one (1) year after the cause of action has accrued.

Yale[®]